

## **SMVector Additional I/O Module** Installation and Operation Manual

## About These Instructions

This documentation applies to the optional Additional I/O module for the SMVector inverter and should be used in conjunction with the SMVector Operating Instructions (Document SV01) that shipped with the drive. These documents should be read in their entirety as they contain important technical data and describe the installation and operation of the drive.



---

**NOTE**

To use the I/O Module with SMVector drives rated at 0.33 to 10 HP (0.25 to 7.5 kW) requires that the drive has software version 3.0 or higher. The software version can be found in the SMVector drive diagnostic parameter P501. To use the I/O Module options the value displayed in P501 must be 3.00 or higher.

SMVector drives rated at 15 HP (11.0 kW) and higher all support the I/O options models so there is no need to verify the value in P501.

---

© 2008 Lenze AC Tech Corporation

No part of this documentation may be copied or made available to third parties without the explicit written approval of Lenze AC Tech Corporation. All information given in this documentation has been carefully selected and tested for compliance with the hardware and software described. Nevertheless, discrepancies cannot be ruled out. Lenze AC Tech does not accept any responsibility nor liability for damages that may occur. Any necessary corrections will be implemented in subsequent editions.

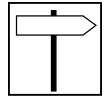

1	Safety Information.....	1
1.1	Warnings, Cautions and Notes .....	1
1.1.1	General .....	1
1.1.2	Application .....	1
1.1.3	Installation .....	1
1.1.4	Electrical Connection.....	2
1.1.5	Operation .....	2
2	Introduction.....	3
2.1	Module Overview .....	3
2.2	Module Specification .....	3
2.3	Module Identification Label .....	3
3	Installation .....	4
3.1	Mechanical Installation .....	4
3.2	Module Terminal Block .....	5
3.3	Electrical Installation.....	6
3.3.1	Terminal Description .....	6
3.3.2	Module Wiring .....	6
4	Commissioning .....	7
4.1	Network Parameters (P400).....	7
4.2	Additional I/O Module Parameters .....	8
4.3	Display .....	10



## 1 Safety Information

### 1.1 Warnings, Cautions and Notes

#### 1.1.1 General

Some parts of Lenze controllers (frequency inverters, servo inverters, DC controllers) can be live, moving and rotating. Some surfaces can be hot.

Non-authorized removal of the required cover, inappropriate use, and incorrect installation or operation creates the risk of severe injury to personnel or damage to equipment.

All operations concerning transport, installation, and commissioning as well as maintenance must be carried out by qualified, skilled personnel (IEC 364 and CENELEC HD 384 or DIN VDE 0100 and IEC report 664 or DIN VDE0110 and national regulations for the prevention of accidents must be observed).

According to this basic safety information, qualified skilled personnel are persons who are familiar with the installation, assembly, commissioning, and operation of the product and who have the qualifications necessary for their occupation.

#### 1.1.2 Application

Drive controllers are components designed for installation in electrical systems or machinery. They are not to be used as appliances. They are intended exclusively for professional and commercial purposes according to EN 61000-3-2. The documentation includes information on compliance with EN 61000-3-2.

When installing the drive controllers in machines, commissioning (i.e. the starting of operation as directed) is prohibited until it is proven that the machine complies with the regulations of the EC Directive 2006/42/EC (Machinery Directive); EN 60204 must be observed.

Commissioning (i.e. starting drive as directed) is only allowed when there is compliance to the EMC Directive (2004/108/EC).

The drive controllers meet the requirements of the Low Voltage Directive 2006/95/EC. The harmonised standards of the series EN 50178/DIN VDE 0160 apply to the controllers.

**The availability of controllers is restricted according to EN 61800-3. These products can cause radio interference in residential areas. In the case of radio interference, special measures may be necessary for drive controllers.**

#### 1.1.3 Installation

Ensure proper handling and avoid excessive mechanical stress. Do not bend any components and do not change any insulation distances during transport or handling. Do not touch any electronic components and contacts. Controllers contain electrostatically sensitive components, which can easily be damaged by inappropriate handling. Do not damage or destroy any electrical components since this might endanger your health! When installing the drive ensure optimal airflow by observing all clearance distances in the drive's user manual. Do not expose the drive to excessive: vibration, temperature, humidity, sunlight, dust, pollutants, corrosive chemicals or other hazardous environments.



# Safety Information

## 1.1.4 Electrical Connection

When working on live drive controllers, applicable national regulations for the prevention of accidents (e.g. VBG 4) must be observed.

The electrical installation must be carried out in accordance with the appropriate regulations (e.g. cable cross-sections, fuses, PE connection). Additional information can be obtained from the regulatory documentation.

The regulatory documentation contains information about installation in compliance with EMC (shielding, grounding, filters and cables). These notes must also be observed for CE-marked controllers.

The manufacturer of the system or machine is responsible for compliance with the required limit values demanded by EMC legislation.

## 1.1.5 Operation

Systems including controllers must be equipped with additional monitoring and protection devices according to the corresponding standards (e.g. technical equipment, regulations for prevention of accidents, etc.). You are allowed to adapt the controller to your application as described in the documentation.



### DANGER!

- After the controller has been disconnected from the supply voltage, do not touch the live components and power connection until the capacitors have discharged. Please observe the corresponding notes on the controller.
- Do not continuously cycle input power to the controller more than once every three minutes.
- Close all protective covers and doors during operation.



### WARNING!

Network control permits automatic starting and stopping of the inverter drive. The system design must incorporate adequate protection to prevent personnel from accessing moving equipment while power is applied to the drive system.

Table 1: Pictographs used in these instructions

Pictograph	Signal word	Meaning	Consequences if ignored
	<b>DANGER!</b>	Warning of Hazardous Electrical Voltage.	Reference to an imminent danger that may result in death or serious personal injury if the corresponding measures are not taken.
	<b>WARNING!</b>	Impending or possible danger for persons	Death or injury
	<b>STOP!</b>	Possible damage to equipment	Damage to drive system or its surroundings
	<b>NOTE</b>	Useful tip: If observed, it will make using the drive easier	

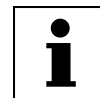

## 2 Introduction

This manual provides installation and operational data specific to the Additional I/O Module for the SMVector series inverters. This manual is a supplement (not a substitution for) the standard SMVector - Frequency Inverter Operating Instructions (document number SV01).

This document assumes that the reader has a working knowledge of the standard SMVector Frequency Inverter and has familiarity with the programming and operation of the SMVector Frequency Inverter. Please consult the SMVector - Frequency Inverter Operating Instructions (SV01) for more details.

### 2.1 Module Overview

The Additional I/O Module is available in two configurations (ESVZAL0, ESVZAL1) for use with the SMVector Frequency Inverter. The modules are intended to supplement the standard I/O functions available in the SMVector inverter.

The I/O module fits into the SMVector inverter terminal cover. This allows for easy field installation and does not add to the overall size of the SMVector inverter.

SMVector inverters that are fitted with an additional I/O module option will no longer have the capability of accommodating an optional communication module.

### 2.2 Module Specification

- P/N ESVZAL0: 1 programmable form C relay output.
- P/N ESVZAL1: 1 programmable form C relay output and 2 programmable digital inputs.

### 2.3 Module Identification Label

Figure 1 illustrates the labels on the SMV Additional I/O Module. The SMVector Additional I/O Module is identifiable by:

- Label affixed to side of the module.
- Part Number ESVZALx on module label.

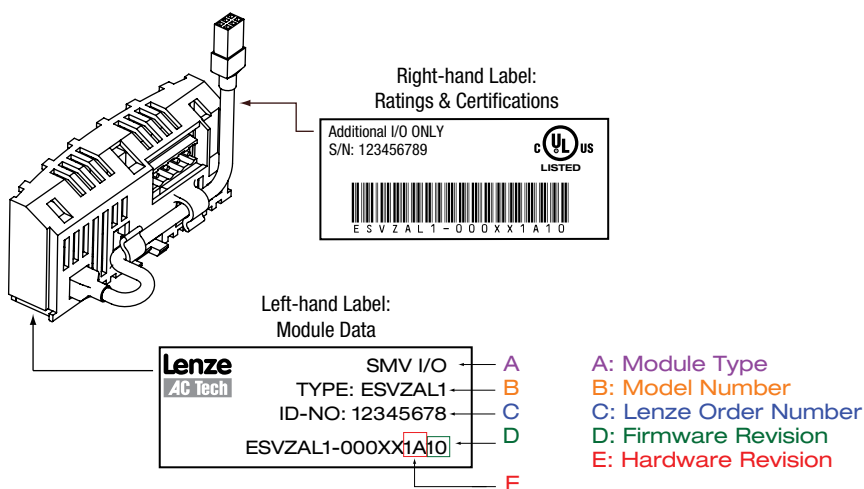

Figure 1: Additional I/O Module Label



# Installation

## 3 Installation

### 3.1 Mechanical Installation

1. Ensure that for safety reasons the AC supply has been disconnected before opening the terminal cover.
2. Insert the Additional I/O module in the terminal cover and securely “click” into position as illustrated in Figure 2.
3. Wire the cables to the connector provided and plug the connector into the option module.
4. Align terminal cover for re-fitting, connect the module umbilical cord to the drive then close the cover and secure, as shown in Figure 3.

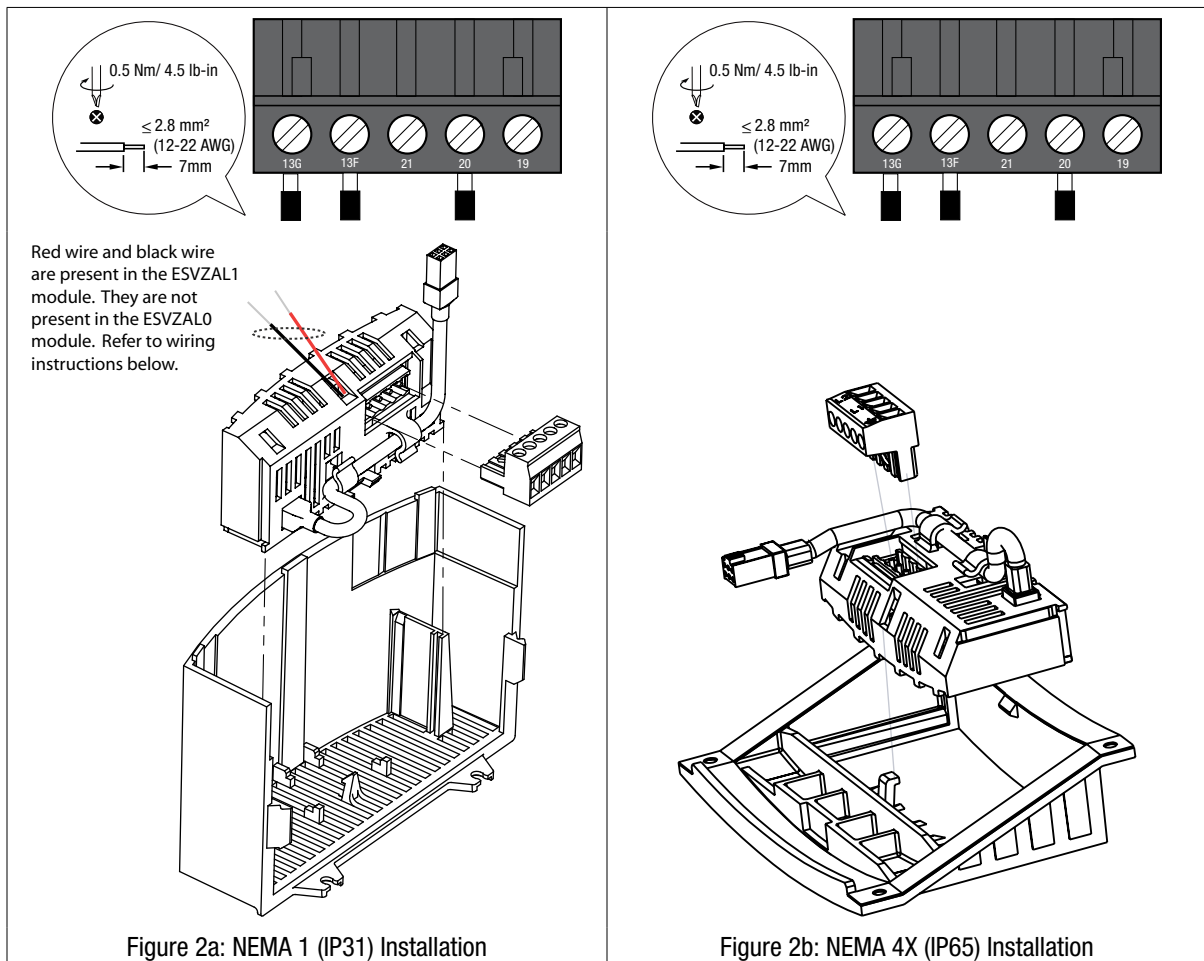

The ESVZAL1 I/O Option Module contains 1 red wire and 1 black wire that must be wired into the standard SMVector Inverter terminal strip.

Connect the black wire to terminal #2.

Connect the red wire to terminal #11.

Refer to adjacent diagram.

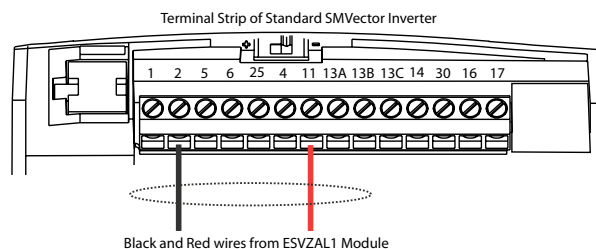

Figure 2c: Wiring the ESVZAL1 I/O Module

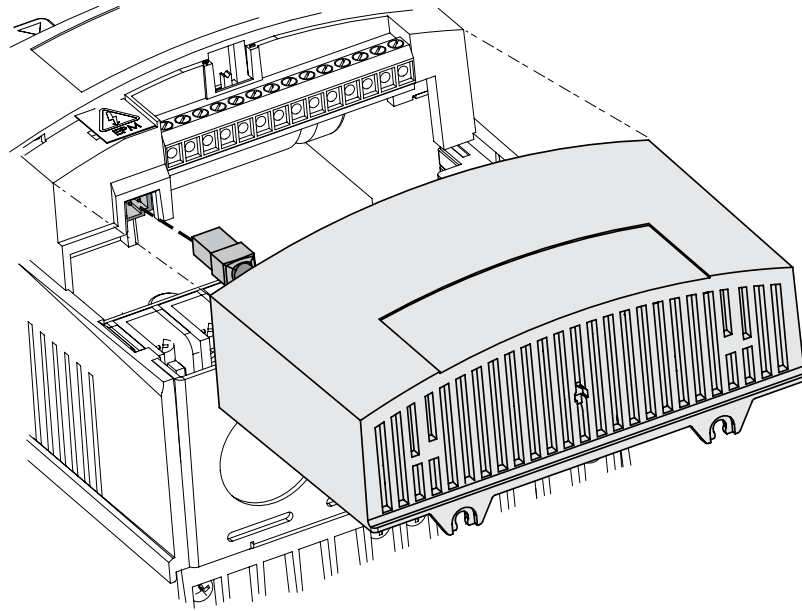
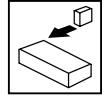

Figure 3: Re-Installing the Terminal Cover

## 3.2 Module Terminal Block

Table 2 identifies the terminals and describes the function of each. Figure 4 illustrates the Additional I/O 5 pole 5mm pluggable connector.

Table 2: Additional I/O Terminals

Terminal	Function	Description
19	Relay N.O.	
20	Relay Common	
21	Relay N.C.	
13F	Digital Input	Available only on ESVZAL1
13G	Digital Input	Available only on ESVZAL1

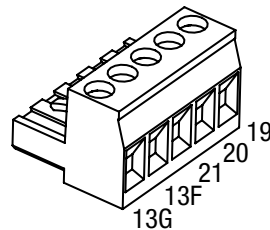

Figure 4: Additional I/O Connector





# Installation

## 3.3 Electrical Installation

### 3.3.1 Terminal Description

Table 3 contains each terminal's electrical specification and any parameter description associated with that terminal.

Table 3: Additional I/O Module Specifications

Terminal	Function	Description
19	Relay N.O.	Relay output configurable with P441, P144 AC 250 V / 3 A 17 DC 24 V / 2 A ... 240 V / 0.22 A, non-inductive
20	Relay Common	
21	Relay N.C.	
13F	Digital Input	13F configurable with P426 13G configurable with P427 Input Impedance = 4.3 kohm The assertion level of Terminals 13F and 13G will match the assertion level of the standard SMVector digital inputs 13A, 13B, 13C, etc... Refer to the description of P120 and Terminal #4 in the SMVector - Frequency Inverter Operating Instructions (SV01)
13G	Digital Input	



#### NOTE

##### For ESVZAL0:

Control and communications terminals provide reinforced insulation when the drive is connected to a power system rated up to 300V between phase to ground (PE) and the applied voltage on terminals 19, 20 and 21 is less than 250 VAC between phase and ground (PE)

##### For ESVZAL1:

Control and communications terminals provide reinforced insulation when the drive is connected to a power system rated up to 300V between phase to ground (PE) and the applied voltage on terminals 19, 20 and 21 is less than 150 VAC between phase and ground (PE)

Control and communications terminals provide basic insulation when the drive is connected to a power system rated up to 300V between phase to ground (PE) and the applied voltage on terminals 19, 20 and 21 is less than 250 VAC between phase and ground (PE).

### 3.3.2 Module Wiring

Figure 5 illustrates the wiring of the ESVZAL0 and ESVZAL1 modules.

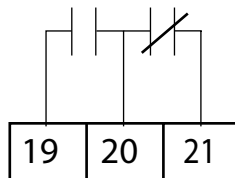

Figure 5a: ESVZAL0

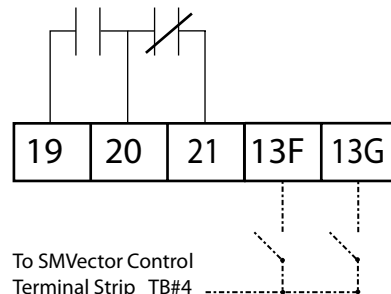

Figure 5b: ESVZAL1



#### NOTE

To assert terminals 13F and 13G with external power sources, refer to section 3.2.3 of the SMVector Operating Instructions (SV01)



## 4 Commissioning

### 4.1 Network Parameters (P400)

Code		Possible Settings		IMPORTANT
No.	Name	Default	Selection	
P400	Network Protocol		0 Not Active 1 Remote Keypad 2 Modbus RTU 3 CANopen 4 DeviceNet 5 Ethernet 6 Profibus 7 Lecom-B 8 I/O Module	This parameter setting is based upon the network or I/O module that is installed.
P401	Module Type Installed	0	0 No Module Installed 1 Basic I/O (0x0100, 1.0.0) 2 RS485/Rem. Keypad (0x0200, 2.0.0) 3 CANopen (0x0300, 3.0.0) 11 PROFIBUS (0x1100, 11.0.0) 12 Ethernet (0x1200, 12.0.0)	Module type format: 0xAABC; Drive Display: AA.B.C AA = Module Type B = Major revision C = minor revision
P402	Module Status	0	0 Not Initialized 1 Initialization: Module to EPM 2 Initialization: EPM to Module 3 Online 4 Failed Initialization Error 5 Time-out Error 6 Initialization Failed 7 Initialization Error	Module type mismatch P401 Protocol selection mismatch P400
P403	Module Reset	0	0 No Action 1 Reset parameters to default values	Returns module parameters 401...499 to the default values shown in the manual
P404	Module Timeout Action	0	0 No Fault 1 STOP (see P111) 2 Quick Stop 3 Fault (F_ntF)	Action to be taken in the event of a Module/ Drive Time-out. Time is fixed at 200ms STOP is by the method selected in P111.
P405	Current Network Fault		0 No Fault 1 F.nF1 2 F.nF2 3 F.nF3 4 F.nF4 5 F.nF5 6 F.nF6 7 F.nF7	NetIdle Mode Loss of Ethernet I/O connection Network Fault Explicit Message Timeout Overall Network Timeout Overall Explicit Timeout Overall I/O Message Timeout
P406	Proprietary			Manufacturer specific
P407 ... P499		Module Specific Parameters		Refer to the Communications Reference Guide specific to the network or I/O module installed.



#### NOTE

Set P400 = 8 for the SMVector drive to communicate with the additional I/O module.



# Commissioning

## 4.2 Additional I/O Module Parameters

In addition to the parameters detailed in the SMVector Frequency Inverter Operating Instructions (SV01), installing the Additional I/O Module provides access to supplementary parameters exclusive to the Additional I/O Module. Table 4 lists these supplementary parameters.

Table 4: Additional I/O Module Parameters

Code		Possible Settings		IMPORTANT
No.	Name	Default	Selection	
P426	TB-13F Input Function	0	0 None	Disables input
			1 AUTO Reference: 0-10 VDC	For frequency mode, see P160...P161,
P427	TB-13G Input Function		2 AUTO Reference: 4-20 mA	For PID mode, see P204...P205, For vector torque mode, see P330
			<b>RESERVED</b>	
			4 AUTO Reference: MOP Up	• Normally open: Close input to increase or decrease speed, PID setpoint or torque setpoint.
			5 AUTO Reference: MOP Down	• MOP Up is not active while in STOP
			6 AUTO Reference: Keypad	
			7 AUTO Reference: Network	
			8 Control Select	Use when P100 = 4, 5 to switch between terminal strip control and local or remote keypad control.
			9 Network Enable	Required to start the drive through the network.
			10 Reverse Rotation	Open = Forward    Closed = Reverse
			11 Start Forward	
			12 Start Reverse	Refer to Note for typical circuit
			13 Run Forward	
			14 Run Reverse	Refer to Note for typical circuit
			15 Jog Forward	Jog Forward speed = P134
			16 Jog Reverse	Jog Reverse speed = P135 ⚠ Active even if P112 = 0
			17 Accel/Decel #2	Refer to P125, P126
			18 DC Brake	Refer to P174; close input to override P175
			19 Auxiliary Ramp to Stop	Normally closed: Opening input will ramp drive to STOP according to P127, even if P111 is set to Coast (0 or 1).
			20 Clear Fault	Close to reset fault
			21 External Fault F_EF	Normally closed circuit; open to trip
			22 Inverse External Fault F_EF	Normally open circuit; close to trip
			<p><b>⚠ WARNING!</b> Jog overrides all STOP commands! To stop the drive while in Jog mode, the Jog input must be deactivated or a fault condition induced.</p>	
<p><b>i NOTE</b></p> <ul style="list-style-type: none"> <li>• When input is activated, settings 1...7 override P101</li> <li>• When TB-13A to TB-13D; TB-13F and TB-13G are configured for Auto References other than MOP, TB-13G overrides TB-13F, TB-13F overrides TB-13D, TB-13D overrides TB-13C, TB-13C overrides TB-13B and TB-13B overrides TB-13A. Any other Auto Reference will have priority over MOP.</li> <li>• Settings 10...14 are only valid in Terminal Strip mode (P100 = 1, 4, 5, 6)</li> <li>• If Start/Run/Jog Forward and Start/Run/Jog Reverse are both activated, drive will STOP</li> <li>• If Jog input is activated while the drive is running, the drive will enter Jog mode; when Jog input is deactivated, drive will STOP</li> <li>• An <b>F_FL</b> fault will occur if the Assertion Level switch (ALSw) position does not match the P120 setting and any of the digital inputs (P121...P124, P426 ... P427) are set to a value other than 0.</li> <li>• An <b>F_IL</b> fault will occur under the following conditions: <ul style="list-style-type: none"> <li>- TB-13A...TB-13D and TB-13F...TB-13G settings are duplicated (each setting, except 0 and 3, can only be used once)</li> <li>- One input is set to "MOP Up" and another is not set to "MOP Down", or vice-versa.</li> <li>- One input is set to 10 and another input is set to 11...14.</li> <li>- One input is set to 11 or 12 and another input is set for 13 or 14.</li> </ul> </li> <li>• TB-13D and P124 exist in 15HP (11kW) and greater drives only</li> </ul>				

# Commissioning



Code		Possible Settings		IMPORTANT																																					
No.	Name	Default	Selection																																						
P441	Relay Output TB-19, 20, 21	0	0 None	Disables the output																																					
			1 Run	Energizes when the drive is running																																					
			2 Reverse	Energizes when reverse rotation is active																																					
			3 Fault	De-energizes when the drive trips, or power is removed																																					
			4 Inverse Fault	Energizes when the drive trips																																					
			5 Fault Lockout	P110 = 3...6: De-energizes if all restart attempts fail																																					
			6 At Speed	Energizes when output frequency = commanded frequency																																					
			7 Above Preset Speed #6	Energizes when output frequency > P136																																					
			8 Current Limit	Energizes when motor current = P171																																					
			9 Follower Loss (4-20 mA)	Energizes when 4-20 mA signal falls below 2 mA																																					
			10 Loss of Load	Energizes when motor load drops below P145; Refer to P146 also																																					
			11 Local Keypad Control Active	Energizes when the selected source is active for start control																																					
			12 Terminal Strip Control Active																																						
			13 Remote Keypad Control Active																																						
			14 Network Control Active																																						
			15 Standard Reference Active	Energizes when P101 reference is active																																					
			16 Auto Reference Active	Energizes when Auto Reference is activated using TB-13 input; refer to P121...P124																																					
			17 Sleep Mode Active	Refer to P240...P242																																					
			18 PID Feedback < Min. Alarm	Energizes when PID feedback signal < P214																																					
			19 Inverse PID Feedback < Min. Alarm	De-energizes when PID feedback signal < P214																																					
			20 PID Feedback > Max Alarm	Energizes when PID feedback signal > P215																																					
			21 Inverse PID Feedback > Max Alarm	De-energizes when PID feedback signal > P215																																					
			22 PID Feedback within Min/Max Alarm range	Energizes when PID feedback signal is within the Min/Max Alarm range; refer to P214, P215																																					
			23 PID Feedback outside Min/Max Alarm range	Energizes when PID feedback signal is outside the Min/Max Alarm range; refer to P214, P215																																					
			24 Reserved																																						
25 Network Activated	Requires 15HP (11kW) or higher drive. No function for 0.33-10HP (0.25kW-7.5kW) drives.																																								
P444	Digital Output Inversion	<table border="1"> <thead> <tr> <th>P144</th> <th>Invert P441</th> <th>Invert P142</th> <th>Invert P140</th> </tr> </thead> <tbody> <tr> <td>0</td> <td>NO</td> <td>NO</td> <td>NO</td> </tr> <tr> <td>1</td> <td>NO</td> <td>NO</td> <td>YES</td> </tr> <tr> <td>2</td> <td>NO</td> <td>YES</td> <td>NO</td> </tr> <tr> <td>3</td> <td>NO</td> <td>YES</td> <td>YES</td> </tr> <tr> <td>4</td> <td>YES</td> <td>NO</td> <td>NO</td> </tr> <tr> <td>5</td> <td>YES</td> <td>NO</td> <td>YES</td> </tr> <tr> <td>6</td> <td>YES</td> <td>YES</td> <td>NO</td> </tr> <tr> <td>7</td> <td>YES</td> <td>YES</td> <td>YES</td> </tr> </tbody> </table>			P144	Invert P441	Invert P142	Invert P140	0	NO	NO	NO	1	NO	NO	YES	2	NO	YES	NO	3	NO	YES	YES	4	YES	NO	NO	5	YES	NO	YES	6	YES	YES	NO	7	YES	YES	YES	<p>Used to invert the selections for P140, P441 (Relay Output) and P142 (TB-14 Output).</p> <p>EXAMPLE: When P140 = 6 (AT SPEED), the relay is energized when output frequency = commanded frequency. IF P144=1, 3, 5 or 7, then P140 is inverted (INVERSE AT SPEED) and the relay is energized when the output frequency does <b>not</b> equal the command frequency.</p>
		P144	Invert P441	Invert P142	Invert P140																																				
		0	NO	NO	NO																																				
		1	NO	NO	YES																																				
		2	NO	YES	NO																																				
		3	NO	YES	YES																																				
		4	YES	NO	NO																																				
		5	YES	NO	YES																																				
6	YES	YES	NO																																						
7	YES	YES	YES																																						
<p><b>i</b> <b>NOTE</b> Inverting P140, P142 or P441 when the parameter is set to NONE (0) will result in the output being energized continuously.</p>																																									



# Commissioning

## 4.3 Display

Parameter P530 allows monitoring of the control terminal points and common drive conditions.

An illuminated LED segment indicates:

- the protective circuit is active (LED 1)
- the Logic Assertion Switch is set to High (+)
- input terminal is asserted (LED 2)
- output terminal is energized (LED 4)
- the Charge Relay is not a terminal, this segment will be illuminated when the Charge Relay is energized (LED 4).

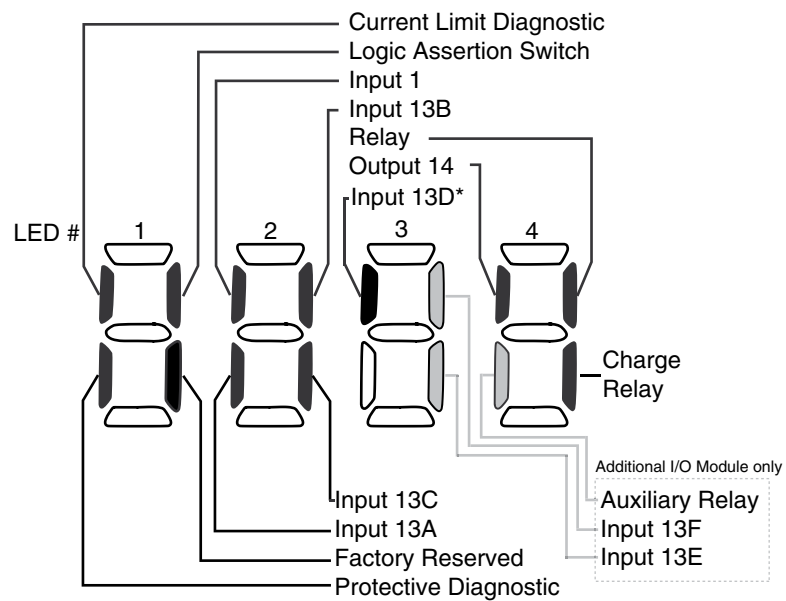

\* Input 13D available on 15-30HP (11-22kW) models only

Figure 6: Status Indicators

**Lenze AC Tech Corporation**

630 Douglas Street • Uxbridge MA 01569 • USA  
Sales: 800-217-9100 • Service: 508-278-9100  
[www.lenzeamericas.com](http://www.lenzeamericas.com)

ALSV01B-en1