









## Ø30 Round Standard Lever Selector Switches (S3SF Series)

Type	Appearance	Operating position	Model	Contact block		LED block	
				A contact	B contact	AC/DC voltage	AC voltage
Standard short lever, flush	 S3SF-S1R□  	2-position, spring return	 <b>S3SF-S1</b> □A(M)	1	—	—	—
			<b>S3SF-S1</b> □2A(M)	2	—		
			<b>S3SF-S1</b> □B(M)	—	1		
			<b>S3SF-S1</b> □2B(M)	—	2		
			<b>S3SF-S1</b> □AB(M)	1	1		
		2-position, maintained	 <b>S3SF-S3</b> □A(M)	1	—		
			<b>S3SF-S3</b> □2A(M)	2	—		
			<b>S3SF-S3</b> □B(M)	—	1		
			<b>S3SF-S3</b> □2B(M)	—	2		
			<b>S3SF-S3</b> □AB(M)	1	1		
		3-position, spring return two-way	 <b>S3SF-S5K</b> □2A(M)	2	—		
			<b>S3SF-S5K</b> □2B(M)	—	2		
			<b>S3SF-S5K</b> □AB(M)	1	1		
		3-position, maintained	 <b>S3SF-S7K</b> □2A(M)	2	—		
			<b>S3SF-S7K</b> □2B(M)	—	2		
			<b>S3SF-S7K</b> □AB(M)	1	1		
		3-position, spring return from right	 <b>S3SF-SAK</b> □2A(M)	2	—		
			<b>S3SF-SAK</b> □2B(M)	—	2		
<b>S3SF-SAK</b> □AB(M)	1		1				
3-position, spring return from left	 <b>S3SF-SCK</b> □2A(M)	2	—				
	<b>S3SF-SCK</b> □2B(M)	—	2				
	<b>S3SF-SCK</b> □AB(M)	1	1				

※□ indicates color : **W**, **R**

※The M in the model name indicates modular type contact block. Models without M are singular contact block.

※The control unit and contact blocks are sold separately.

(control unit: bold letters, contact block: regular letters)

※Connect up to 2 contact blocks. Connect the contact blocks only on the right and left side slots. It will not operate if connected to the center slot.

• Dimensions

(unit: mm)

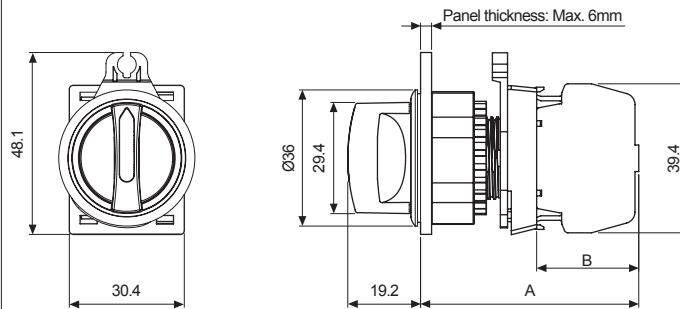

※For panel cut-out dimensions, please refer to page A-105.

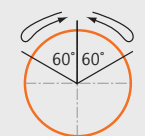
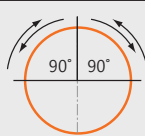
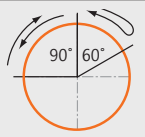
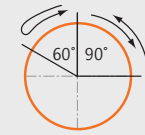
Type	Appearance	Operating position		Model	Contact block		LED block	
					A contact	B contact	AC/DC voltage	AC voltage
Standard short lever, flush		3-position, spring return two-way		S3SF-S5□2A(M)	2	—	—	—
				S3SF-S5□2B(M)	—	2		
				S3SF-S5□AB(M)	1	1		
		3-position, maintained		S3SF-S7□2A(M)	2	—		
				S3SF-S7□2B(M)	—	2		
				S3SF-S7□AB(M)	1	1		
		3-position, spring return from right		S3SF-SA□2A(M)	2	—		
				S3SF-SA□2B(M)	—	2		
				S3SF-SA□AB(M)	1	1		
		3-position, spring return from left		S3SF-SC□2A(M)	2	—		
				S3SF-SC□2B(M)	—	2		
				S3SF-SC□AB(M)	1	1		

S3SF-S1R□



※□ indicates color : **W**, **R**

※The M in the model name indicates modular type contact block. Models without M are singular contact block.

※The control unit and contact blocks are sold separately.

(control unit: bold letters, contact block: regular letters)

※Connect up to 2 contact blocks. Connect the contact blocks only on the right and left side slots.

It will not operate if connected to the center slot.

• Dimensions

(unit: mm)

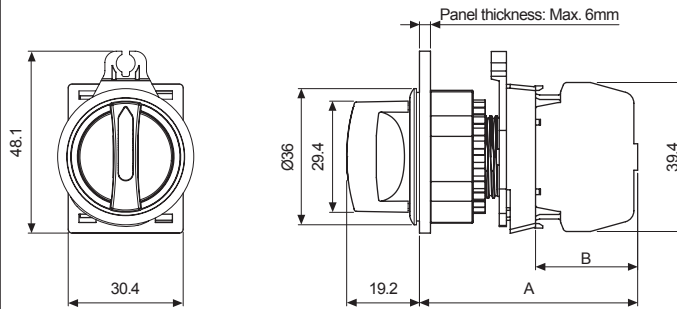

	A	B
Singular type	57.7	27.0
Modular type	55.7	25.0

※For panel cut-out dimensions, please refer to page A-105.

# Ø30 Selector Switches

Type	Appearance	Operating position	Model	Contact block		LED block	
				A contact	B contact	AC/DC voltage	AC voltage
Standard long lever, flush		2-position, spring return	 S3SF-S2□A(M)	1	—	—	—
			S3SF-S2□2A(M)	2	—		
			S3SF-S2□B(M)	—	1		
			S3SF-S2□2B(M)	—	2		
			S3SF-S2□AB(M)	1	1		
			2-position, maintained	 S3SF-S4□A(M)	1		
		S3SF-S4□2A(M)		2	—		
		S3SF-S4□B(M)		—	1		
		S3SF-S4□2B(M)		—	2		
		S3SF-S4□AB(M)		1	1		
		3-position, spring return two-way		 S3SF-S6K□2A(M)	2		
			S3SF-S6K□2B(M)	—	2		
			S3SF-S6K□AB(M)	1	1		
		3-position, maintained	 S3SF-S8K□2A(M)	2	—		
			S3SF-S8K□2B(M)	—	2		
			S3SF-S8K□AB(M)	1	1		
		3-position, spring return from right	 S3SF-SBK□2A(M)	2	—		
			S3SF-SBK□2B(M)	—	2		
			S3SF-SBK□AB(M)	1	1		
		3-position, spring return from left	 S3SF-SDK□2A(M)	2	—		
			S3SF-SDK□2B(M)	—	2		
			S3SF-SDK□AB(M)	1	1		

※□ indicates color : **W**, **R**

※The M in the model name indicates modular type contact block. Models without M are singular contact block.

※The control unit and contact blocks are sold separately.  
(control unit: bold letters, contact block: regular letters)

※Connect up to 2 contact blocks. Connect the contact blocks only on the right and left side slots.  
It will not operate if connected to the center slot.

• Dimensions

(unit: mm)

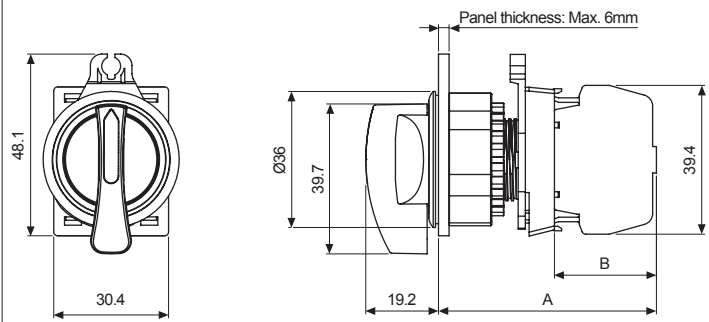

	A	B
Singular type	57.7	27.0
Modular type	55.7	25.0

※For panel cut-out dimensions, please refer to page A-105.

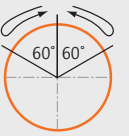
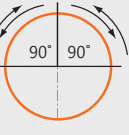
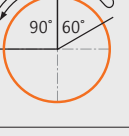
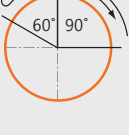
Type	Appearance	Operating position		Model	Contact block		LED block	
					A contact	B contact	AC/DC voltage	AC voltage
Standard long lever, flush		3-position, spring return two-way		<b>S3SF-S6</b> □2A(M)	2	—	—	—
				<b>S3SF-S6</b> □2B(M)	—	2		
				<b>S3SF-S6</b> □2AB(M)	1	1		
		3-position, maintained		<b>S3SF-S8</b> □2A(M)	2	—		
				<b>S3SF-S8</b> □2B(M)	—	2		
				<b>S3SF-S8</b> □AB(M)	1	1		
		3-position, spring return from right		<b>S3SF-SB</b> □2A(M)	2	—		
				<b>S3SF-SB</b> □2B(M)	—	2		
				<b>S3SF-SB</b> □AB(M)	1	1		
		3-position, spring return from left		<b>S3SF-SD</b> □2A(M)	2	—		
				<b>S3SF-SD</b> □2B(M)	—	2		
				<b>S3SF-SD</b> □AB(M)	1	1		

S3SF-S2W□



※□ indicates color : W, R  
 ※The M in the model name indicates modular type contact block. Models without M are singular contact block.  
 ※The control unit and contact blocks are sold separately.  
 (control unit: bold letters, contact block: regular letters)  
 ※Connect up to 2 contact blocks. Connect the contact blocks only on the right and left side slots.  
 It will not operate if connected to the center slot.

• Dimensions



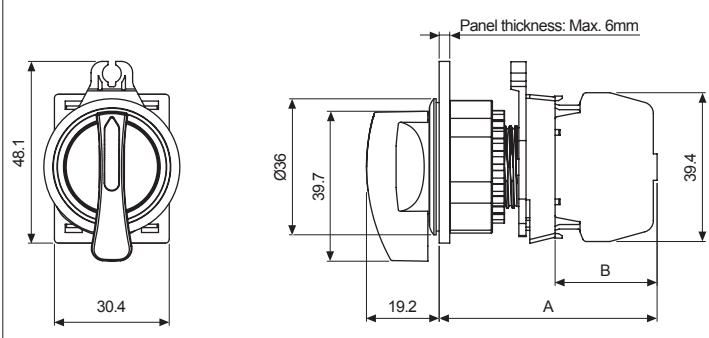

(unit: mm)

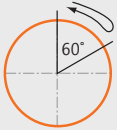

	A	B
Singular type	57.7	27.0
Modular type	55.7	25.0

※For panel cut-out dimensions, please refer to page A-105.

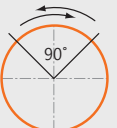
## Ø30 Round Shark Lever Selector Switches (S3SFN Series)

Type	Appearance	Operating position		Model	Contact block		LED block	
					A contact	B contact	AC/DC voltage	AC voltage
Short shark-head lever, flush	 S3SFN-S1AW□	2-position, spring return		S3SFN-S1A□A(M)	1	—	—	—
				S3SFN-S1A□2A(M)	2	—		
				S3SFN-S1A□B(M)	—	1		
				S3SFN-S1A□2B(M)	—	2		
				S3SFN-S1A□AB(M)	1	1		
				S3SFN-S3A□A(M)	1	—		
		2-position, maintained		S3SFN-S3A□2A(M)	2	—		
				S3SFN-S3A□B(M)	—	1		
				S3SFN-S3A□2B(M)	—	2		
				S3SFN-S3A□AB(M)	1	1		
				S3SFN-S1B□A(M)	1	—		
				S3SFN-S1B□2A(M)	2	—		
		2-position, spring return		S3SFN-S1B□B(M)	—	1		
				S3SFN-S1B□2B(M)	—	2		
				S3SFN-S1B□AB(M)	1	1		
				S3SFN-S3B□A(M)	1	—		
				S3SFN-S3B□2A(M)	2	—		
				S3SFN-S3B□B(M)	—	1		
		2-position, maintained		S3SFN-S3B□2B(M)	—	2		
				S3SFN-S3B□AB(M)	1	1		
				S3SFN-S1□A(M)	1	—		
				S3SFN-S1□2A(M)	2	—		
				S3SFN-S1□B(M)	—	1		
				S3SFN-S1□2B(M)	—	2		
2-position, spring return		S3SFN-S1□AB(M)	1	1				





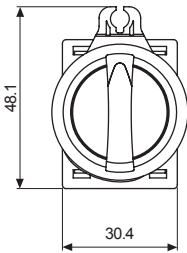
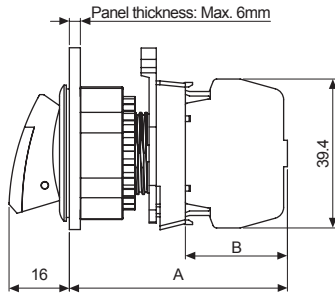

※□ indicates color : **W**, **R**  
 ※The M in the model name indicates modular type contact block. Models without M are singular contact block.  
 ※The control unit and contact blocks are sold separately.  
 (control unit: bold letters, contact block: regular letters)  
 ※Connect up to 2 contact blocks. Connect the contact blocks only on the right and left side slots.  
 It will not operate if connected to the center slot.

• Dimensions (unit: mm)

	A	B
Singular type	57.7	27.0
Modular type	55.7	25.0

※For panel cut-out dimensions, please refer to page A-105.

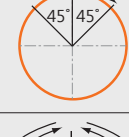
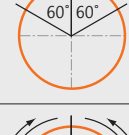
Type	Appearance	Operating position		Model	Contact block		LED block	
					A contact	B contact	AC/DC voltage	AC voltage
Short shark-head lever, flush		3-position, spring return two-way		S3SFN-S5K□2A(M)	2	—	—	—
				S3SFN-S5K□2B(M)	—	2		
				S3SFN-S5K□AB(M)	1	1		
		3-position, maintained		S3SFN-S7K□2A(M)	2	—		
				S3SFN-S7K□2B(M)	—	2		
				S3SFN-S7K□AB(M)	1	1		
		3-position, spring return from right		S3SFN-SAK□2A(M)	2	—		
				S2SFN-SAK□2B(M)	—	2		
				S2SFN-SAK□AB(M)	1	1		
		3-position, spring return from left		S2SFN-SCK□2A(M)	2	—		
				S2SFN-SCK□2B(M)	—	2		
				S2SFN-SCK□AB(M)	1	1		
		3-position, spring return two-way		S3SFN-S5□2A(M)	2	—		
				S3SFN-S5□2B(M)	—	2		
				S3SFN-S5□AB(M)	1	1		
		3-position, maintained		S3SFN-S7□2A(M)	2	—		
				S3SFN-S7□2B(M)	—	2		
				S3SFN-S7□AB(M)	1	1		
		3-position, spring return from right		S3SFN-SA□2A(M)	2	—		
				S2SFN-SA□2B(M)	—	2		
				S2SFN-SA□AB(M)	1	1		
		3-position, spring return from left		S2SFN-SC□2A(M)	2	—		
				S2SFN-SC□2B(M)	—	2		
				S2SFN-SC□AB(M)	1	1		

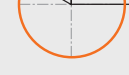
※□ indicates color : **W**, **R**

※The M in the model name indicates modular type contact block. Models without M are singular contact block.

※The control unit and contact blocks are sold separately.

(control unit: bold letters, contact block: regular letters)

※Connect up to 2 contact blocks. Connect the contact blocks only on the right and left side slots. It will not operate if connected to the center slot.

• Dimensions

(unit: mm)

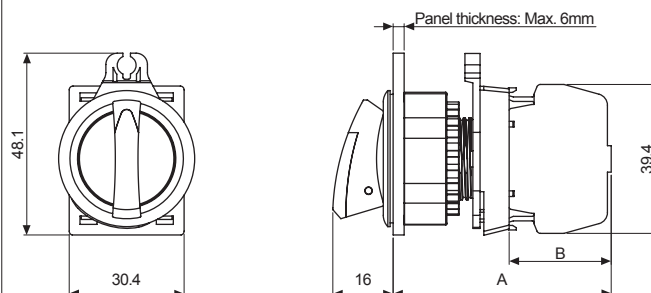

	A	B
Singular type	57.7	27.0
Modular type	55.7	25.0

※For panel cut-out dimensions, please refer to page A-105.

# Ø30 Selector Switches

Type	Appearance	Operating position	Model	Contact block		LED block	
				A contact	B contact	AC/DC voltage	AC voltage
Long shark-head lever, flush	 S3SFN-S2AR□  	2-position, spring return 	S3SFN-S2A□A(M)	1	—	—	—
			S3SFN-S2A□2A(M)	2	—		
			S3SFN-S2A□B(M)	—	1		
			S3SFN-S2A□2B(M)	—	2		
		2-position, maintained 	S3SFN-S2A□AB(M)	1	1		
			S3SFN-S4A□A(M)	1	—		
			S3SFN-S4A□2A(M)	2	—		
			S3SFN-S4A□B(M)	—	1		
		2-position, spring return 	S3SFN-S4A□2B(M)	—	2		
			S3SFN-S4A□AB(M)	1	1		
			S3SFN-S2B□A(M)	1	—		
			S3SFN-S2B□2A(M)	2	—		
		2-position, maintained 	S3SFN-S2B□B(M)	—	1		
			S3SFN-S2B□2B(M)	—	2		
			S3SFN-S2B□AB(M)	1	1		
			S3SFN-S4B□A(M)	1	—		
		2-position, maintained 	S3SFN-S4B□2A(M)	2	—		
			S3SFN-S4B□B(M)	—	1		
			S3SFN-S4B□2B(M)	—	2		
			S3SFN-S4B□AB(M)	1	1		
		2-position, spring return 	S3SFN-S2□A(M)	1	—		
			S3SFN-S2□2A(M)	2	—		
			S3SFN-S2□B(M)	—	1		
			S3SFN-S2□2B(M)	—	2		
		S3SFN-S2□AB(M)		1	1		

※□ indicates color : **W**, **R**

※The M in the model name indicates modular type contact block. Models without M are singular contact block.

※The control unit and contact blocks are sold separately.

(control unit: bold letters, contact block: regular letters)

※Connect up to 2 contact blocks. Connect the contact blocks only on the right and left side slots.

It will not operate if connected to the center slot.



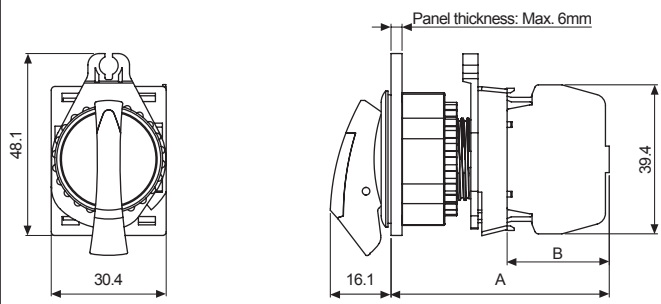

• Dimensions

(unit: mm)



	A	B
Singular type	57.7	27.0
Modular type	55.7	25.0

※For panel cut-out dimensions, please refer to page A-105.

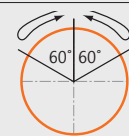
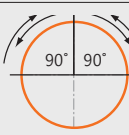
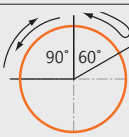
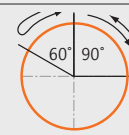
Type	Appearance	Operating position		Model	Contact block		LED block	
					A contact	B contact	AC/DC voltage	AC voltage
Long shark-head lever, flush		3-position, spring return two-way		<b>S3SFN-S6K</b> □2A(M)	2	—	—	—
				<b>S3SFN-S6K</b> □2B(M)	—	2		
				<b>S3SFN-S6K</b> □AB(M)	1	1		
		3-position, maintained		<b>S3SFN-S8K</b> □2A(M)	2	—		
				<b>S3SFN-S8K</b> □2B(M)	—	2		
				<b>S3SFN-S8K</b> □AB(M)	1	1		
		3-position, spring return from right		<b>S3SFN-SBK</b> □2A(M)	2	—		
				<b>S3SFN-SBK</b> □2B(M)	—	2		
				<b>S3SFN-SBK</b> □AB(M)	1	1		
		3-position, spring return from left		<b>S3SFN-SDK</b> □2A(M)	2	—		
				<b>S3SFN-SDK</b> □2B(M)	—	2		
				<b>S3SFN-SDK</b> □AB(M)	1	1		
		3-position, spring return two-way		<b>S3SFN-S6</b> □2A(M)	2	—		
				<b>S3SFN-S6</b> □2B(M)	—	2		
				<b>S3SFN-S6</b> □AB(M)	1	1		
		3-position, maintained		<b>S3SFN-S8</b> □2A(M)	2	—		
				<b>S3SFN-S8</b> □2B(M)	—	2		
				<b>S3SFN-S8</b> □AB(M)	1	1		
		3-position, spring return from right		<b>S3SFN-SB</b> □2A(M)	2	—		
				<b>S3SFN-SB</b> □2B(M)	—	2		
				<b>S3SFN-SB</b> □AB(M)	1	1		
		3-position, spring return from left		<b>S3SFN-SD</b> □2A(M)	2	—		
				<b>S3SFN-SD</b> □2B(M)	—	2		
				<b>S3SFN-SD</b> □AB(M)	1	1		

□ indicates color : **W**, **R**

※The M in the model name indicates modular type contact block. Models without M are singular contact block.

※The control unit and contact blocks are sold separately.

(control unit: bold letters, contact block: regular letters)

※Connect up to 2 contact blocks. Connect the contact blocks only on the right and left side slots.

It will not operate if connected to the center slot.

• Dimensions

(unit: mm)

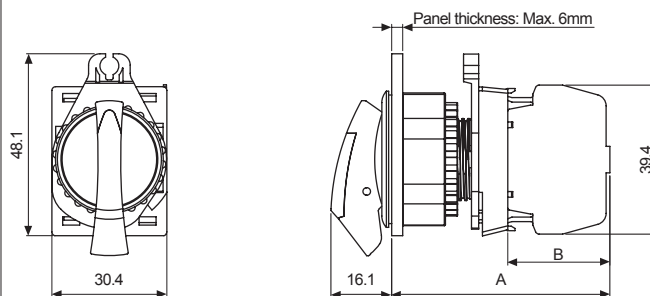

	A	B
Singular type	57.7	27.0
Modular type	55.7	25.0

※For panel cut-out dimensions, please refer to page A-105.



# Ø30 Selector Switches

Type	Appearance	Operating position		Model	Contact block		LED block	
					A contact	B contact	AC/DC voltage	AC voltage
Short shark-head lever, flush (illuminated)		2-position, spring return		S3SFN-L1A□AL(M)	1	—	—	1
				S3SFN-L1A□2AL(M)	2	—		
				S3SFN-L1A□BL(M)	—	1		
				S3SFN-L1A□2BL(M)	—	2		
				S3SFN-L1A□ABL(M)	1	1		
		2-position, maintained		S3SFN-L3A□AL(M)	1	—		
				S3SFN-L3A□2AL(M)	2	—		
				S3SFN-L3A□BL(M)	—	1		
				S3SFN-L3A□2BL(M)	—	2		
		2-position, spring return		S3SFN-L1B□AL(M)	1	—		
				S3SFN-L1B□2AL(M)	2	—		
				S3SFN-L1B□BL(M)	—	1		
				S3SFN-L1B□2BL(M)	—	2		
				S3SFN-L1B□ABL(M)	1	1		
		2-position, maintained		S3SFN-L3B□AL(M)	1	—		
				S3SFN-L3B□2AL(M)	2	—		
				S3SFN-L3B□BL(M)	—	1		
				S3SFN-L3B□2BL(M)	—	2		
		2-position, spring return		S3SFN-L1□AL(M)	1	—		
				S3SFN-L1□2AL(M)	2	—		
				S3SFN-L1□BL(M)	—	1		
				S3SFN-L1□2BL(M)	—	2		
				S3SFN-L1□ABL(M)	1	1		

※□ indicates color : R, B, G, Y

※The M in the model name indicates modular type contact block. Models without M are singular contact block.

※Connect up to 2 contact blocks. Connect the contact blocks only on the right and left side slots.

It will not operate if connected to the center slot.

※The LED color is the same as the control unit.



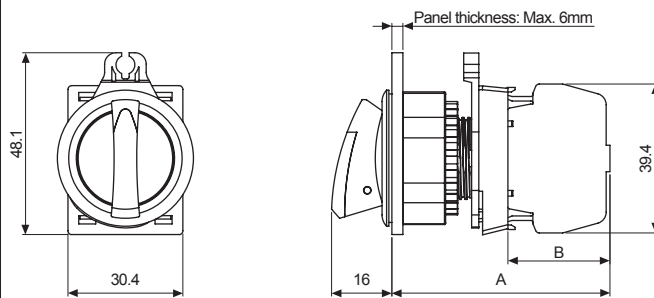

• Dimensions

(unit: mm)



	A	B
Singular type	57.7	27.0
Modular type	55.7	25.0

※For panel cut-out dimensions, please refer to page A-105.

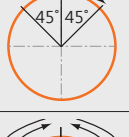
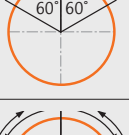
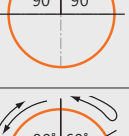
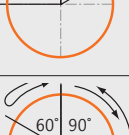
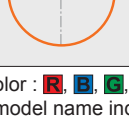
Type	Appearance	Operating position		Model	Contact block		LED block	
					A contact	B contact	AC/DC voltage	AC voltage
Short shark-head lever, flush (illuminated)		3-position, spring return two-way		S3SFN-L5K□2AL(M)	2	—	—	1
				S3SFN-L5K□2BL(M)	—	2		
				S3SFN-L5K□ABL(M)	1	1		
		3-position, maintained		S3SFN-L7K□2AL(M)	2	—		
				S3SFN-L7K□2BL(M)	—	2		
				S3SFN-L7K□ABL(M)	1	1		
		3-position, spring return from right		S3SFN-LAK□2AL(M)	2	—		
				S3SFN-LAK□2BL(M)	—	2		
				S3SFN-LAK□ABL(M)	1	1		
		3-position, spring return from left		S3SFN-LCK□2AL(M)	2	—		
				S3SFN-LCK□2BL(M)	—	2		
				S3SFN-LCK□ABL(M)	1	1		
		3-position, spring return two-way		S3SFN-L5□2AL(M)	2	—		
				S3SFN-L5□2BL(M)	—	2		
				S3SFN-L5□ABL(M)	1	1		
		3-position, maintained		S3SFN-L7□2AL(M)	2	—		
				S3SFN-L7□2BL(M)	—	2		
				S3SFN-L7□ABL(M)	1	1		
		3-position, spring return from right		S3SFN-LA□2AL(M)	2	—		
				S3SFN-LA□2BL(M)	—	2		
				S3SFN-LA□ABL(M)	1	1		
		3-position, spring return from left		S3SFN-LC□2AL(M)	2	—		
				S3SFN-LC□2BL(M)	—	2		
				S3SFN-LC□ABL(M)	1	1		

※□ indicates color : **R**, **B**, **G**, **Y**

※The M in the model name indicates modular type contact block. Models without M are singular contact block.

※Connect up to 2 contact blocks. Connect the contact blocks only on the right and left side slots. It will not operate if connected to the center slot.

※The LED color is the same as the control unit.

• Dimensions

(unit: mm)

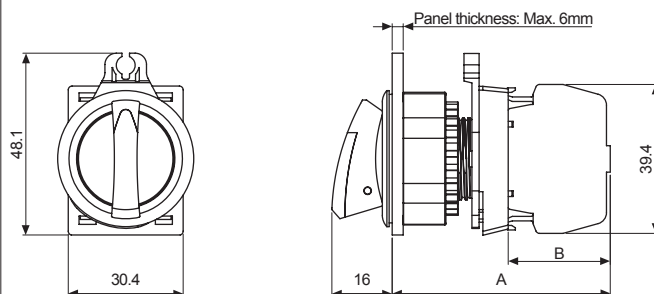

	A	B
Singular type	57.7	27.0
Modular type	55.7	25.0

※For panel cut-out dimensions, please refer to page A-105.

# Ø30 Selector Switches

Type	Appearance	Operating position		Model	Contact block		LED block	
					A contact	B contact	AC/DC voltage	AC voltage
Short shark-head lever, flush (illuminated)		2-position, spring return		S3SFN-L1A□AD(M)	1	—	1	—
				S3SFN-L1A□2AD(M)	2	—		
				S3SFN-L1A□BD(M)	—	1		
				S3SFN-L1A□2BD(M)	—	2		
				S3SFN-L1A□ABD(M)	1	1		
		2-position, maintained		S3SFN-L3A□AD(M)	1	—		
				S3SFN-L3A□2AD(M)	2	—		
				S3SFN-L3A□BD(M)	—	1		
				S3SFN-L3A□2BD(M)	—	2		
				S3SFN-L3A□ABD(M)	1	1		
		2-position, spring return		S3SFN-L1B□AD(M)	1	—		
				S3SFN-L1B□2AD(M)	2	—		
				S3SFN-L1B□BD(M)	—	1		
				S3SFN-L1B□2BD(M)	—	2		
				S3SFN-L1B□ABD(M)	1	1		
		2-position, maintained		S3SFN-L3B□AD(M)	1	—		
				S3SFN-L3B□2AD(M)	2	—		
				S3SFN-L3B□BD(M)	—	1		
				S3SFN-L3B□2BD(M)	—	2		
				S3SFN-L3B□ABD(M)	1	1		
		2-position, spring return		S3SFN-L1□AD(M)	1	—		
				S3SFN-L1□2AD(M)	2	—		
				S3SFN-L1□BD(M)	—	1		
				S3SFN-L1□2BD(M)	—	2		
S3SFN-L1□ABD(M)	1			1				

※□ indicates color : ■ ■ ■ ■

※The M in the model name indicates modular type contact block. Models without M are singular contact block.

※Connect up to 2 contact blocks. Connect the contact blocks only on the right and left side slots.

It will not operate if connected to the center slot.

※The LED color is the same as the control unit.





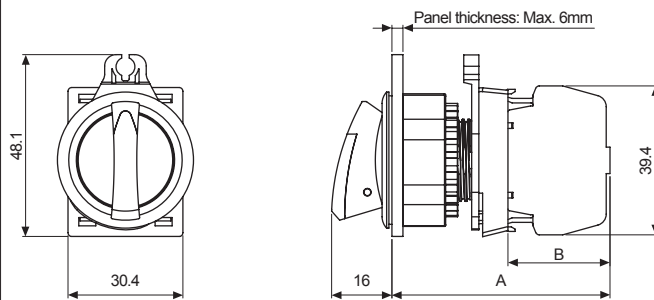

• Dimensions

(unit: mm)



	A	B
Singular type	57.7	27.0
Modular type	55.7	25.0

※For panel cut-out dimensions, please refer to page A-105.

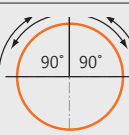
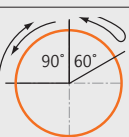
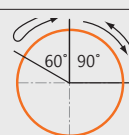
Type	Appearance	Operating position		Model	Contact block		LED block	
					A contact	B contact	AC/DC voltage	AC voltage
Short shark-head lever, flush (illuminated)		3-position, spring return two-way		S3SFN-L5K□2AD(M)	2	—	1	—
				S3SFN-L5K□2BD(M)	—	2		
				S3SFN-L5K□ABD(M)	1	1		
		3-position, maintained		S3SFN-L7K□2AD(M)	2	—		
				S3SFN-L7K□2BD(M)	—	2		
				S3SFN-L7K□ABD(M)	1	1		
		3-position, spring return from right		S3SFN-LAK□2AD(M)	2	—		
				S3SFN-LAK□2BD(M)	—	2		
				S3SFN-LAK□ABD(M)	1	1		
		3-position, spring return from left		S3SFN-LCK□2AD(M)	2	—		
				S3SFN-LCK□2BD(M)	—	2		
				S3SFN-LCK□ABD(M)	1	1		
		3-position, spring return two-way		S3SFN-L5□2AD(M)	2	—		
				S3SFN-L5□2BD(M)	—	2		
				S3SFN-L5□ABD(M)	1	1		
		3-position, maintained		S3SFN-L7□2AD(M)	2	—		
				S3SFN-L7□2BD(M)	—	2		
				S3SFN-L7□ABD(M)	1	1		
		3-position, spring return from right		S3SFN-LA□2AD(M)	2	—		
				S3SFN-LA□2BD(M)	—	2		
				S3SFN-LA□ABD(M)	1	1		
		3-position, spring return from left		S3SFN-LC□2AD(M)	2	—		
				S3SFN-LC□2BD(M)	—	2		
				S3SFN-LC□ABD(M)	1	1		

※□ indicates color : R, B, G, Y  
 ※The M in the model name indicates modular type contact block. Models without M are singular contact block.  
 ※Connect up to 2 contact blocks. Connect the contact blocks only on the right and left side slots.  
 It will not operate if connected to the center slot.  
 ※The LED color is the same as the control unit.

• Dimensions

(unit: mm)

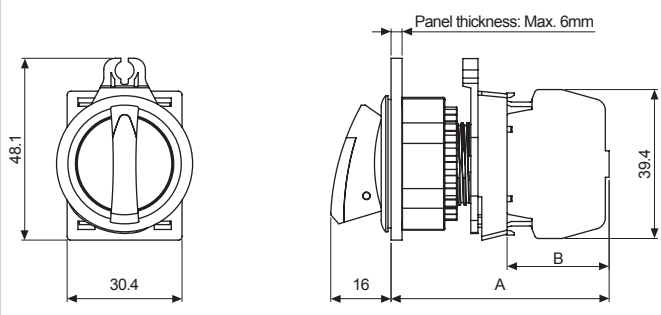

	A	B
Singular type	57.7	27.0
Modular type	55.7	25.0

※For panel cut-out dimensions, please refer to page A-105.

# Ø30 Selector Switches

Type	Appearance	Operating position	Model	Contact block		LED block	
				A contact	B contact	AC/DC voltage	AC voltage
Long shark-head lever, flush (illuminated)	 S3SFN-L2AG	2-position, spring return 	S3SFN-L2A□AL(M)	1	—	—	1
			S3SFN-L2A□2AL(M)	2	—		
			S3SFN-L2A□BL(M)	—	1		
			S3SFN-L2A□2BL(M)	—	2		
		2-position, maintained 	S3SFN-L2A□ABL(M)	1	1		
			S3SFN-L4A□AL(M)	1	—		
			S3SFN-L4A□2AL(M)	2	—		
			S3SFN-L4A□BL(M)	—	1		
		2-position, spring return 	S3SFN-L2B□AL(M)	1	—		
			S3SFN-L2B□2AL(M)	2	—		
			S3SFN-L2B□BL(M)	—	1		
			S3SFN-L2B□2BL(M)	—	2		
		2-position, maintained 	S3SFN-L2B□ABL(M)	1	1		
			S3SFN-L4B□AL(M)	1	—		
			S3SFN-L4B□2AL(M)	2	—		
			S3SFN-L4B□BL(M)	—	1		
		2-position, spring return 	S3SFN-L4B□2BL(M)	—	2		
			S3SFN-L4B□ABL(M)	1	1		
			S3SFN-L2□AL(M)	1	—		
			S3SFN-L2□2AL(M)	2	—		
			S3SFN-L2□BL(M)	—	1		
			S3SFN-L2□2BL(M)	—	2		
			S3SFN-L2□ABL(M)	1	1		

※□ indicates color : R, B, G, Y

※The M in the model name indicates modular type contact block. Models without M are singular contact block.

※The control unit, contact blocks, LED blocks are sold separately.

(control unit: bold letters, contact and LED block: regular letters)

※Connect up to 2 contact blocks. Connect the contact blocks only on the right and left side slots. It will not operate if connected to the center slot.

※The LED color is the same as the control unit.

• Dimensions

(unit: mm)

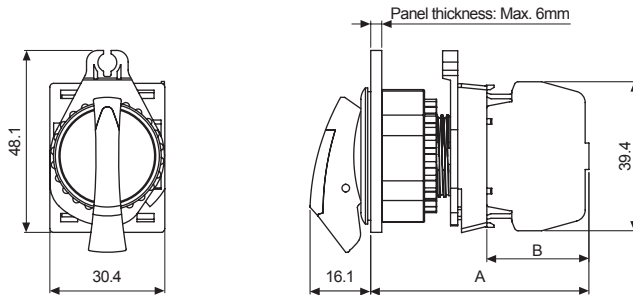

	A	B
Singular type	57.7	27.0
Modular type	55.7	25.0

※For panel cut-out dimensions, please refer to page A-105.



Control Switches

Ø16

Ø22/25

**Ø30**

□30

Push Button Switches

- Round
- Square
- Rectangular

Selector Switches

- Round**
- Square
- Rectangular

Key Selector Switches

- Round
- Square
- Rectangular

Double Push Button Switches







Mushroom-head Push Button Switches

Emergency Switches

Pilot Lights

Accessories

Buzzers

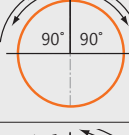
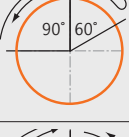
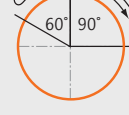
Type	Appearance	Operating position	Model	Contact block		LED block	
				A contact	B contact	AC/DC voltage	AC voltage
Long shark-head lever, flush (illuminated)	 S3SFN-L2AG□ 	3-position, spring return two-way	 S3SFN-L6K□2AL(M)	2	—	—	1
			S3SFN-L6K□2BL(M)	—	2		
			S3SFN-L6K□ABL(M)	1	1		
		3-position, maintained	 S3SFN-L8K□2AL(M)	2	—		
			S3SFN-L8K□2BL(M)	—	2		
			S3SFN-L8K□ABL(M)	1	1		
		3-position, spring return from right	 S3SFN-LBK□2AL(M)	2	—		
			S3SFN-LBK□2BL(M)	—	2		
			S3SFN-LBK□ABL(M)	1	1		
		3-position, spring return from left	 S3SFN-LDK□2AL(M)	2	—		
			S3SFN-LDK□2BL(M)	—	2		
			S3SFN-LDK□ABL(M)	1	1		
		3-position, spring return two-way	 S3SFN-L6□2AL(M)	2	—		
			S3SFN-L6□2BL(M)	—	2		
			S3SFN-L6□ABL(M)	1	1		
		3-position, maintained	 S3SFN-L8□2AL(M)	2	—		
			S3SFN-L8□2BL(M)	—	2		
			S3SFN-L8□ABL(M)	1	1		
		3-position, spring return from right	 S3SFN-LB□2AL(M)	2	—		
			S3SFN-LB□2BL(M)	—	2		
			S3SFN-LB□ABL(M)	1	1		
		3-position, spring return from left	 S3SFN-LD□2AL(M)	2	—		
			S3SFN-LD□2BL(M)	—	2		
			S3SFN-LD□ABL(M)	1	1		

※□ indicates color : **R**, **B**, **G**, **Y**

※The M in the model name indicates modular type contact block. Models without M are singular contact block.

※The control unit, contact blocks, LED blocks are sold separately.

(control unit: bold letters, contact and LED block: regular letters)

※Connect up to 2 contact blocks. Connect the contact blocks only on the right and left side slots.

It will not operate if connected to the center slot.

※The LED color is the same as the control unit.

• Dimensions

(unit: mm)

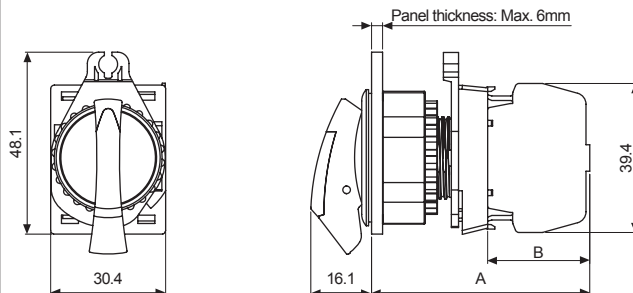

	A	B
Singular type	57.7	27.0
Modular type	55.7	25.0

※For panel cut-out dimensions, please refer to page A-105.

# Ø30 Selector Switches

Type	Appearance	Operating position		Model	Contact block		LED block	
					A contact	B contact	AC/DC voltage	AC voltage
Long shark-head lever, flush (illuminated)		2-position, spring return		S3SFN-L2A□AD(M)	1	—	1	—
				S3SFN-L2A□2AD(M)	2	—		
				S3SFN-L2A□BD(M)	—	1		
				S3SFN-L2A□2BD(M)	—	2		
				S3SFN-L2A□ABD(M)	1	1		
		2-position, maintained		S3SFN-L4A□AD(M)	1	—		
				S3SFN-L4A□2AD(M)	2	—		
				S3SFN-L4A□BD(M)	—	1		
				S3SFN-L4A□2BD(M)	—	2		
				S3SFN-L4A□ABD(M)	1	1		
		2-position, spring return		S3SFN-L2B□AD(M)	1	—		
				S3SFN-L2B□2AD(M)	2	—		
				S3SFN-L2B□BD(M)	—	1		
				S3SFN-L2B□2BD(M)	—	2		
				S3SFN-L2B□ABD(M)	1	1		
		2-position, maintained		S3SFN-L4B□AD(M)	1	—		
				S3SFN-L4B□2AD(M)	2	—		
				S3SFN-L4B□BD(M)	—	1		
				S3SFN-L4B□2BD(M)	—	2		
				S3SFN-L4B□ABD(M)	1	1		
2-position, spring return		S3SFN-L2□AD(M)	1	—				
		S3SFN-L2□2AD(M)	2	—				
		S3SFN-L2□BD(M)	—	1				
		S3SFN-L2□2BD(M)	—	2				
		S3SFN-L2□ABD(M)	1	1				

※□ indicates color : R, B, G, Y  
 ※The M in the model name indicates modular type contact block. Models without M are singular contact block.  
 ※The control unit, contact blocks, LED blocks are sold separately.  
 (control unit: bold letters, contact and LED block: regular letters)  
 ※Connect up to 2 contact blocks. Connect the contact blocks only on the right and left side slots.  
 It will not operate if connected to the center slot.  
 ※The LED color is the same as the control unit.



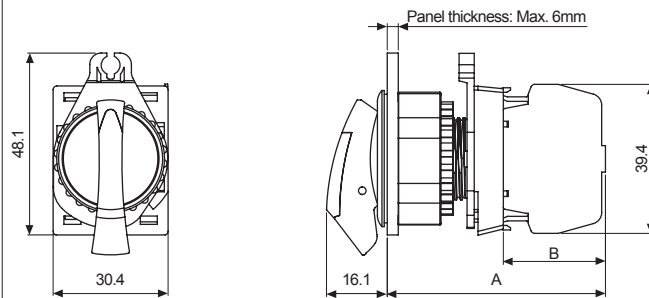

• Dimensions

(unit: mm)



	A	B
Singular type	57.7	27.0
Modular type	55.7	25.0

※For panel cut-out dimensions, please refer to page A-105.

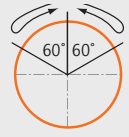
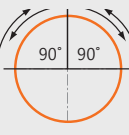
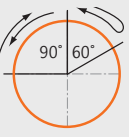
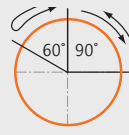
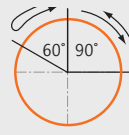
Type	Appearance	Operating position	Model	Contact block		LED block		
				A contact	B contact	AC/DC voltage	AC voltage	
Long shark-head lever, flush (illuminated)	 S3SFN-L2AG□  	3-position, spring return two-way	 S3SFN-L6K□2AD(M)	2	—	1	—	
			S3SFN-L6K□2BD(M)	—	2			
			S3SFN-L6K□ABD(M)	1	1			
		3-position, maintained		S3SFN-L8K□2AD(M)	2			—
				S3SFN-L8K□2BD(M)	—			2
				S3SFN-L8K□ABD(M)	1			1
		3-position, spring return from right		S3SFN-LBK□2AD(M)	2			—
				S3SFN-LBK□2BD(M)	—			2
				S3SFN-LBK□ABD(M)	1			1
		3-position, spring return from left		S3SFN-LDK□2AD(M)	2			—
				S3SFN-LDK□2BD(M)	—			2
				S3SFN-LDK□ABD(M)	1			1
		3-position, spring return two-way		S3SFN-L6□2AD(M)	2			—
				S3SFN-L6□2BD(M)	—			2
				S3SFN-L6□ABD(M)	1			1
		3-position, maintained		S3SFN-L8□2AD(M)	2			—
				S3SFN-L8□2BD(M)	—			2
				S3SFN-L8□ABD(M)	1			1
		3-position, spring return from right		S3SFN-LB□2AD(M)	2			—
				S3SFN-LB□2BD(M)	—			2
				S3SFN-LB□ABD(M)	1			1
		3-position, spring return from left		S3SFN-LD□2AD(M)	2			—
				S3SFN-LD□2BD(M)	—			2
				S3SFN-LD□ABD(M)	1			1

※□ indicates color : **R**, **B**, **G**, **Y**

※The M in the model name indicates modular type contact block. Models without M are singular contact block.

※The control unit, contact blocks, LED blocks are sold separately.

(control unit: bold letters, contact and LED block: regular letters)

※Connect up to 2 contact blocks. Connect the contact blocks only on the right and left side slots.

It will not operate if connected to the center slot.

※The LED color is the same as the control unit.

• Dimensions

(unit: mm)

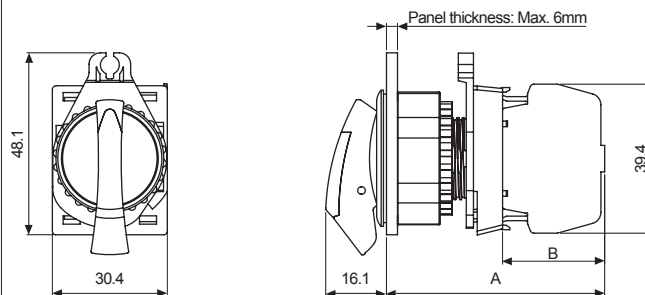

	A	B
Singular type	57.7	27.0
Modular type	55.7	25.0





※For panel cut-out dimensions, please refer to page A-105.

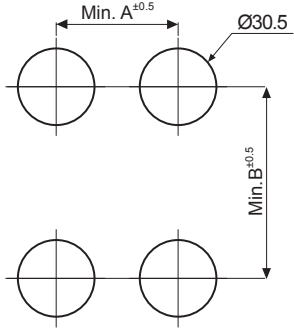

# Ø30 Panel Cut-out Dimensions

## Ø30 Panel Cut-out Dimensions

(unit: mm)

Type		A	B	Panel Cut-out Dimensions
Round Push Button Switches (S3PR/S3PF Series)		45	55	
Round Selector Switches (S3SF/S3SFN Series)	Short lever 	37	55	
	Long lever 	55	55	
Round Key Selector Switches (S3KF Series)		37	55	
Pilot Lights (L3RF Series)		37	55	

### Control Switches

Ø16

Ø22/25

Ø30

□30

### Push Button Switches

Round

Square

Rectangular

### Selector Switches

Round

Square

Rectangular

### Key Selector Switches

Round

Square

Rectangular

### Double Push Button Switches

### Mushroom-head Push Button Switches

### Emergency Switches

### Pilot Lights

### Accessories

### Buzzers