

# Product data sheet

Specifications



analog output module, Modicon  
TM5, 4O, +/-10V, 0 to 20mA,  
12bits

TM5SAO4L

## Main

Range Of Product	Modicon TM5
Product Or Component Type	Analog output module
Analogue Output Number	4
Analogue Output Resolution	12 bits + sign, +/- 10 V 12 bits, 0...20 mA

## Complementary

Range Compatibility	Modicon LMC058 Modicon M258
Product Compatibility	Logic controller Motion controller
Analogue Output Type	Current 0...20 mA Voltage +/- 10 V
Measurement Resolution	4.882 mV, +/- 10 V 9.766 µA, 0...20 mA
Colour	White
Response Time	<= 1 ms
Minimum Output Impedance	1 Ohm
Load Impedance Ohmic	200...500 Ohm(current)
Sampling Duration	300 µs
Measurement Error	< 0.08 % of full scale +/- 10 V +/- 10 V 25 °C < 0.08 % of full scale 0...20 mA 0...20 mA 25 °C
Temperature Coefficient	0.015 %FS/°C current 0.015 %FS/°C voltage
Non-Linearity	< 0.005 %FS current < 0.005 %FS voltage
Type Of Cable	Shielded cable
Isolation	500 Vrms AC insulation between channel and bus No insulation between channels
Supply	Internal
[Us] Rated Supply Voltage	24 V DC -15...20 %
Local Signalling	1 LED green power supply 1 LED red power supply 4 LEDs yellow output status
Current Consumption	2 mA 5 V DC bus 63 mA 24 V DC input/output
Maximum Power Dissipation In W	1.51 W

Marking	CE
Net Weight	0.06 lb(US) (0.025 kg)

## Environment

Standards	IEC 61131-2 CSA C22.2 No 213 UL 508 CSA C22.2 No 142
Product Certifications	cULus GOST-R CSA C-Tick
Ambient Air Temperature For Operation	32...131 °F (0...55 °C) without derating horizontal installation 32...140 °F (0...60 °C) with derating factor horizontal installation 32...122 °F (0...50 °C) vertical installation)
Ambient Air Temperature For Storage	-13...158 °F (-25...70 °C)
Relative Humidity	5...95 % without condensation
Ip Degree Of Protection	IP20IEC 61131-2
Pollution Degree	2 IEC 60664
Operating Altitude	0...2000 m
Storage Altitude	0.00...9842.52 ft (0...3000 m)
Vibration Resistance	1 gn 8.4...150 Hz DIN rail 3.5 mm 5...8.4 Hz DIN rail
Shock Resistance	15 gn 11 ms
Resistance To Electrostatic Discharge	4 kV on contact IEC 61000-4-2 8 kV in air IEC 61000-4-2
Resistance To Electromagnetic Fields	0.91 V/yd (1 V/m) 2...2.7 GHz IEC 61000-4-3 9.14 V/yd (10 V/m) 80...2000 MHz IEC 61000-4-3
Resistance To Fast Transients	1 kV IEC 61000-4-4 I/O) 1 kV IEC 61000-4-4 shielded cable) 2 kV IEC 61000-4-4 power lines)
Surge Withstand	0.5 kV differential mode IEC 61000-4-5 1 kV common mode IEC 61000-4-5
Electromagnetic Compatibility	EN/IEC 61000-4-6
Disturbance Radiated/Conducted	CISPR 11

## Packing Units

Unit Type Of Package 1	PCE
Number Of Units In Package 1	1
Package 1 Height	0.79 in (2.000 cm)
Package 1 Width	2.36 in (6.000 cm)
Package 1 Length	4.33 in (11.000 cm)
Package 1 Weight	1.38 oz (39.000 g)
Unit Type Of Package 2	S02
Number Of Units In Package 2	97
Package 2 Height	5.91 in (15.000 cm)
Package 2 Width	11.81 in (30.000 cm)
Package 2 Length	15.75 in (40.000 cm)

---

Package 2 Weight

9.86 lb(US) (4.471 kg)

## Contractual warranty

---

Warranty

18 months

## Sustainability

**Green Premium™ label** is Schneider Electric's commitment to delivering products with best-in-class environmental performance. Green Premium promises compliance with the latest regulations, transparency on environmental impacts, as well as circular and low-CO<sub>2</sub> products.

**Guide to assessing product sustainability** is a white paper that clarifies global eco-label standards and how to interpret environmental declarations.

[Learn more about Green Premium >](#)

[Guide to assess a product's sustainability >](#)



Transparency RoHS/REACH

## Well-being performance

Toxic Heavy Metal Free

Mercury Free

Rohs Exemption Information [Yes](#)

Pvc Free

## Certifications & Standards

**Reach Regulation**

[REACH Declaration](#)

**Eu Rohs Directive**

Pro-active compliance (Product out of EU RoHS legal scope)

**China Rohs Regulation**

[China RoHS declaration](#)

**Environmental Disclosure**

[Product Environmental Profile](#)

**Weee**

The product must be disposed on European Union markets following specific waste collection and never end up in rubbish bins

**Circularity Profile**

[End of Life Information](#)

Dimensions Drawings

TM5 Slice

---

Dimensions

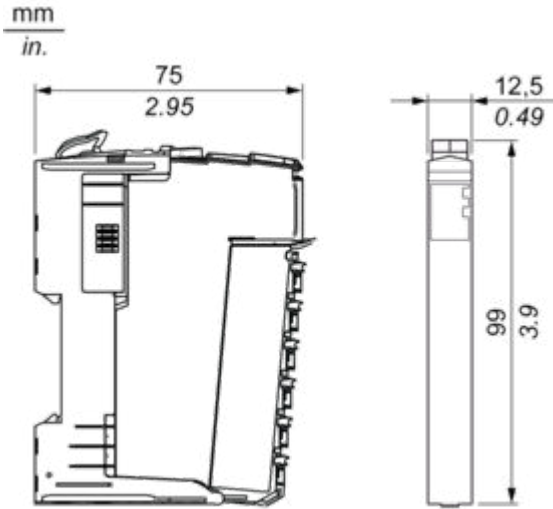

Mounting and Clearance

TM5 System

Spacing Requirements

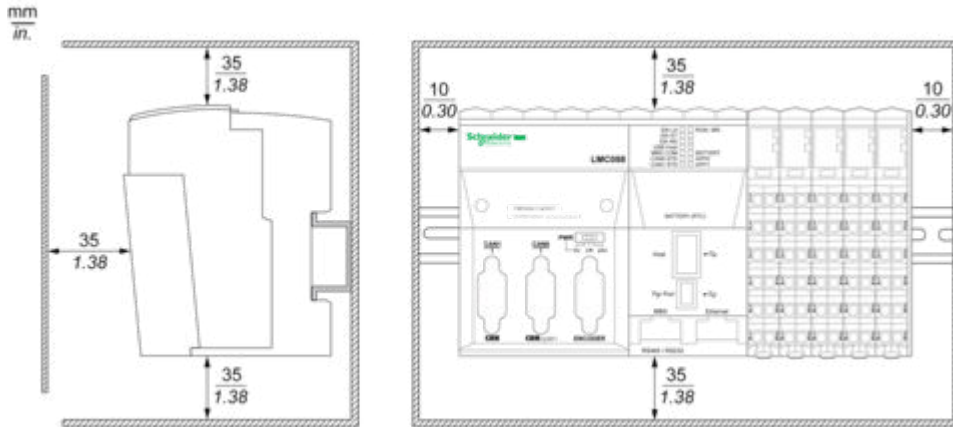

Mounting on a DIN Rail

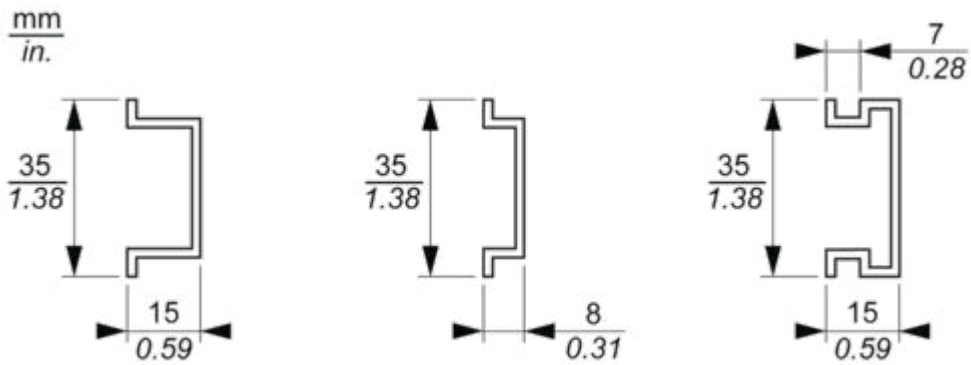





Connections and Schema

**TM5 System Wiring Recommendations**

---

**Wire Sizes to Use with the Removable Spring Terminal Blocks**

 mm in.				
mm <sup>2</sup>	0,08...2,5	0,25...2,5	0,25...1,5	2 x 0,25...2 x 0,75
AWG	28...14	24...14	24...16	2 x 24...2 x 18

Electronic Module 4AO  $\pm 10V/0-20mA$  12 Bits

Wiring Diagram

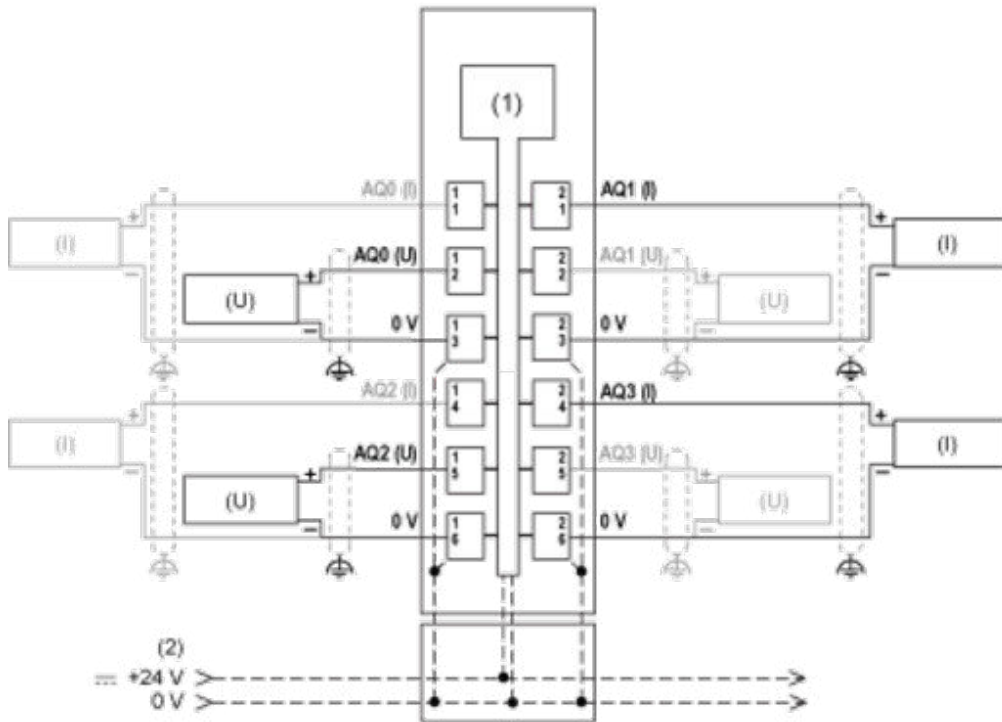

- (1) Internal electronics
- (2) 24 Vdc I/O power segment integrated into the bus bases
- (I) Current
- (U) Voltage