

Product data sheet

Specifications



remote receiver module, Modicon TM5, communication between RIO, distribute power

TM5SBER2

Main

Range Of Product	Modicon TM5
Product Or Component Type	Remote receiver module
Product Specific Application	Communication between remote I/O Distribute power to TM5 bus and I/O

Complementary

Range Compatibility	Modicon M258 Modicon LMC058
Product Compatibility	Logic controller Motion controller
Colour	Grey
Bus Length	8202.10 ft (2500 m)
Maximum Cable Distance Between Devices	328.08 ft (100 m)
Current Consumption	25 mA 24 V DC input/output
Maximum Power Dissipation In W	2.22 W
Local Signalling	1 LED green power supply 1 LED red power bus current 1 LED red power supply 1 LED yellow communication data bus
Marking	CE
Net Weight	0.06 lb(US) (0.025 kg)

Environment

Standards	CSA C22.2 No 142 CSA C22.2 No 213 IEC 61131-2 UL 508
Product Certifications	CSA cULus C-Tick GOST-R
Ambient Air Temperature For Operation	32...122 °F (0...50 °C) vertical installation) 32...131 °F (0...55 °C) without derating horizontal installation) 32...140 °F (0...60 °C) with derating factor horizontal installation)
Ambient Air Temperature For Storage	-13...158 °F (-25...70 °C)
Relative Humidity	5...95 % without condensation
Ip Degree Of Protection	IP20IEC 61131-2 IP67
Pollution Degree	2 IEC 60664

Operating Altitude	0...2000 m
Storage Altitude	0.00...9842.52 ft (0...3000 m)
Vibration Resistance	1 gn 8.4...150 Hz DIN rail 3.5 mm 5...8.4 Hz DIN rail
Shock Resistance	15 gn 11 ms
Resistance To Electrostatic Discharge	4 kV on contact IEC 61000-4-2 8 kV in air IEC 61000-4-2
Resistance To Electromagnetic Fields	0.91 V/yd (1 V/m) 2...2.7 GHz IEC 61000-4-3 9.14 V/yd (10 V/m) 80...2000 MHz IEC 61000-4-3
Resistance To Fast Transients	1 kV IEC 61000-4-4 I/O) 1 kV IEC 61000-4-4 shielded cable) 2 kV IEC 61000-4-4 power lines)
Surge Withstand	0.5 kV differential mode IEC 61000-4-5 1 kV common mode IEC 61000-4-5
Electromagnetic Compatibility	EN/IEC 61000-4-6
Disturbance Radiated/Conducted	CISPR 11

Packing Units

Unit Type Of Package 1	PCE
Number Of Units In Package 1	1
Package 1 Height	1.18 in (3.000 cm)
Package 1 Width	2.36 in (6.000 cm)
Package 1 Length	4.13 in (10.500 cm)
Package 1 Weight	2.12 oz (60.000 g)
Unit Type Of Package 2	S02
Number Of Units In Package 2	50
Package 2 Height	5.91 in (15.000 cm)
Package 2 Width	11.81 in (30.000 cm)
Package 2 Length	15.75 in (40.000 cm)
Package 2 Weight	7.28 lb(US) (3.300 kg)

Contractual warranty

Warranty	18 months
-----------------	-----------

Sustainability

Green Premium™ label is Schneider Electric's commitment to delivering products with best-in-class environmental performance. Green Premium promises compliance with the latest regulations, transparency on environmental impacts, as well as circular and low-CO₂ products.

Guide to assessing product sustainability is a white paper that clarifies global eco-label standards and how to interpret environmental declarations.

[Learn more about Green Premium >](#)

[Guide to assess a product's sustainability >](#)



Transparency RoHS/REACH

Well-being performance

Toxic Heavy Metal Free

Mercury Free

Rohs Exemption Information Yes

Pvc Free

Certifications & Standards

Reach Regulation

[REACH Declaration](#)

Eu Rohs Directive

Pro-active compliance (Product out of EU RoHS legal scope)

China Rohs Regulation

[China RoHS declaration](#)

Environmental Disclosure

[Product Environmental Profile](#)

Weee

The product must be disposed on European Union markets following specific waste collection and never end up in rubbish bins

Circularity Profile

[End of Life Information](#)

Dimensions Drawings

TM5 Slice

Dimensions

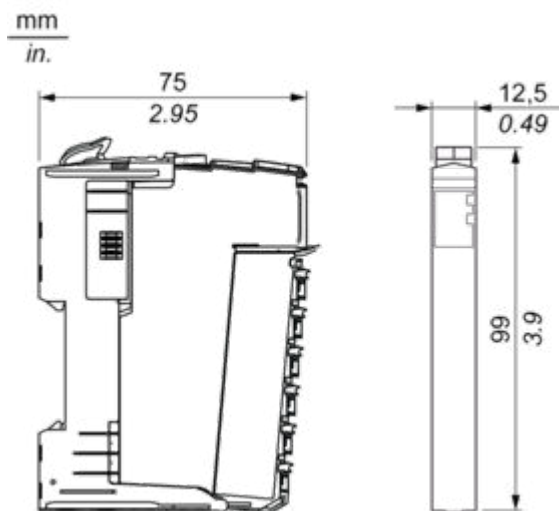

Mounting and Clearance

TM5 System

Spacing Requirements

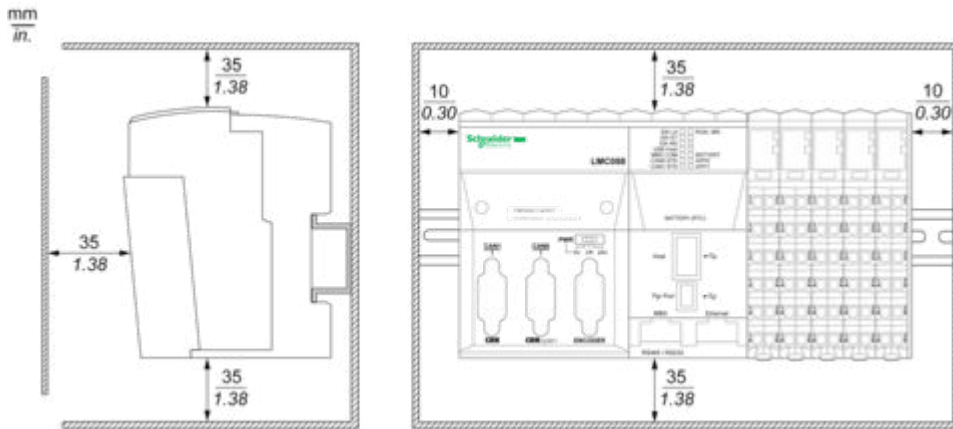



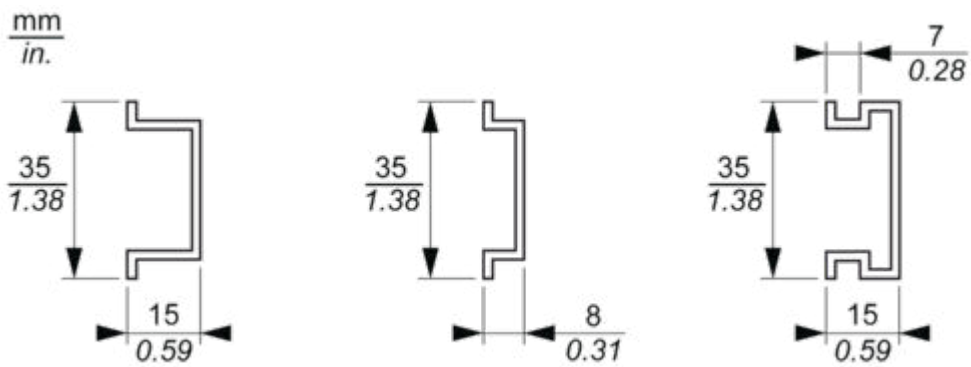

Mounting on a DIN Rail



Connections and Schema

TM5 System Wiring Recommendations

Wire Sizes to Use with the Removable Spring Terminal Blocks

 mm in.				
mm ²	0,08...2,5	0,25...2,5	0,25...1,5	2 x 0,25...2 x 0,75
AWG	28...14	24...14	24...16	2 x 24...2 x 18

Receiver Electronic Module

Wiring Diagram

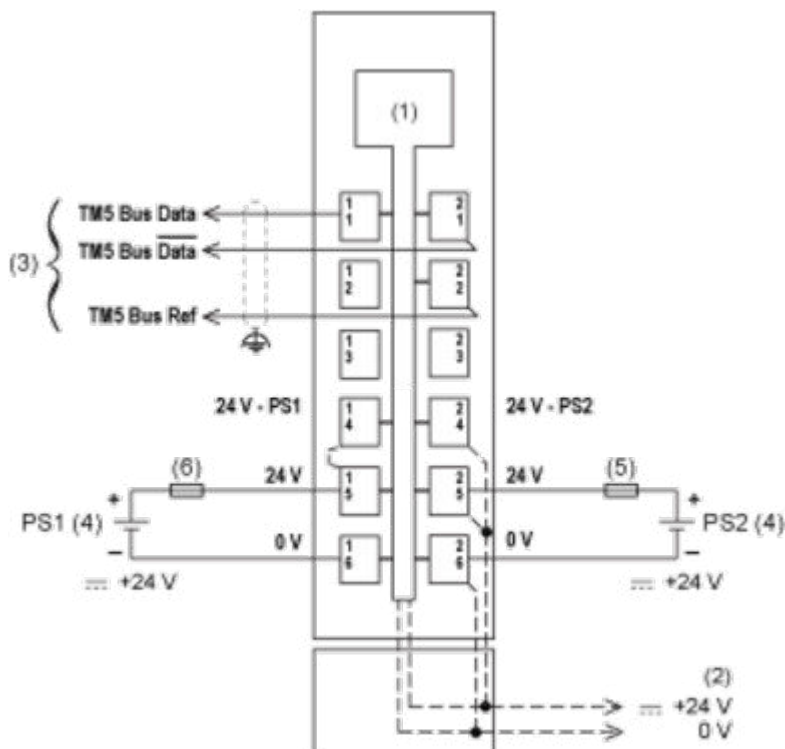

- (1) Internal electronics
- (2) 24 Vdc I/O power segment integrated into the bus bases
- (3) TM5 expansion bus cable (TCSXCNNXNX100)
- (4) PS1/PS2: External isolated SELV power supply 24 Vdc limited to 200 VA for UL508 conformance, or limited to 150 VA for CSA 22.2, N° 142 conformance
- (5) External fuse, Type T slow-blow: 10 A max., 250 V
- (6) External fuse, Type T slow-blow: 1 A, 250 V