

Product data sheet

Specifications



Remote transmitter module, Modicon TM5, communication between I/O IP20 and IP67

TM5SBET7

Main

| | |
|------------------------------|----------------------------------|
| Range Of Product | Modicon TM5 |
| Product Or Component Type | Remote transmitter module |
| Product Specific Application | Communication between remote I/O |

Complementary

| | |
|---|---|
| Range Compatibility | Modicon M258 Modicon LMC058 |
| Product Compatibility | Motion controller Logic controller |
| [Us] Rated Supply Voltage | 24 V DC - 15...20 % |
| Colour | White |
| Bus Length | 8202.10 ft (2500 m) |
| Maximum Cable Distance Between Devices | 328.08 ft (100 m) |
| Current Consumption | 25 mA 24 V DC input/output 100 mA 5 V DC bus |
| Maximum Power Dissipation In W | 1.1 W |
| Local Signalling | 1 LED green power supply 1 LED red power supply 1 LED yellow communication data bus |
| Supply | Included for IP67 extension modules |
| Marking | CE |
| Net Weight | 0.06 lb(US) (0.025 kg) |

Environment

| | |
|--|--|
| Standards | UL 508 CSA C22.2 No 142 IEC 61131-2 CSA C22.2 No 213 |
| Product Certifications | CSA GOST-R cULus C-Tick |
| Ambient Air Temperature For Operation | 32...122 °F (0...50 °C) vertical installation) 32...131 °F (0...55 °C) without derating horizontal installation) 32...140 °F (0...60 °C) with derating factor horizontal installation) |
| Ambient Air Temperature For Storage | -13...158 °F (-25...70 °C) |
| Relative Humidity | 5...95 % without condensation |

| | |
|--|--|
| Ip Degree Of Protection | IP20 IEC 61131-2 IP67 |
| Pollution Degree | 2 IEC 60664 |
| Operating Altitude | 0...2000 m |
| Storage Altitude | 0.00...9842.52 ft (0...3000 m) |
| Vibration Resistance | 1 gn 8.4...150 Hz DIN rail 3.5 mm 5...8.4 Hz DIN rail |
| Shock Resistance | 15 gn 11 ms |
| Resistance To Electrostatic Discharge | 4 kV on contact IEC 61000-4-2 8 kV in air IEC 61000-4-2 |
| Resistance To Electromagnetic Fields | 0.91 V/yd (1 V/m) 2...2.7 GHz IEC 61000-4-3 9.14 V/yd (10 V/m) 80...2000 MHz IEC 61000-4-3 |
| Resistance To Fast Transients | 1 kV IEC 61000-4-4 I/O 1 kV IEC 61000-4-4 shielded cable 2 kV IEC 61000-4-4 power lines) |
| Surge Withstand | 0.5 kV differential mode IEC 61000-4-5 1 kV common mode IEC 61000-4-5 |
| Electromagnetic Compatibility | EN/IEC 61000-4-6 |
| Disturbance Radiated/Conducted | CISPR 11 |

Packing Units

| | |
|-------------------------------------|-------------------------|
| Unit Type Of Package 1 | PCE |
| Number Of Units In Package 1 | 1 |
| Package 1 Height | 0.79 in (2.000 cm) |
| Package 1 Width | 2.36 in (6.000 cm) |
| Package 1 Length | 4.13 in (10.500 cm) |
| Package 1 Weight | 1.76 oz (50.000 g) |
| Unit Type Of Package 2 | S02 |
| Number Of Units In Package 2 | 97 |
| Package 2 Height | 5.91 in (15.000 cm) |
| Package 2 Width | 11.81 in (30.000 cm) |
| Package 2 Length | 15.75 in (40.000 cm) |
| Package 2 Weight | 11.41 lb(US) (5.177 kg) |

Contractual warranty

| | |
|-----------------|-----------|
| Warranty | 18 months |
|-----------------|-----------|

Sustainability

Green Premium™ label is Schneider Electric's commitment to delivering products with best-in-class environmental performance. Green Premium promises compliance with the latest regulations, transparency on environmental impacts, as well as circular and low-CO₂ products.

Guide to assessing product sustainability is a white paper that clarifies global eco-label standards and how to interpret environmental declarations.

[Learn more about Green Premium >](#)

[Guide to assess a product's sustainability >](#)



Transparency RoHS/REACH

Well-being performance

✓ Reach Free Of Svhc

✓ Toxic Heavy Metal Free

✓ Mercury Free

✓ Rohs Exemption Information Yes

✓ Pvc Free

Certifications & Standards

Reach Regulation

[REACH Declaration](#)

Eu Rohs Directive

Pro-active compliance (Product out of EU RoHS legal scope)

[EU RoHS Declaration](#)

China Rohs Regulation

[China RoHS declaration](#)

Environmental Disclosure

[Product Environmental Profile](#)

Weee

The product must be disposed on European Union markets following specific waste collection and never end up in rubbish bins

Circularity Profile

[End of Life Information](#)

Dimensions Drawings

TM5 Slice

Dimensions

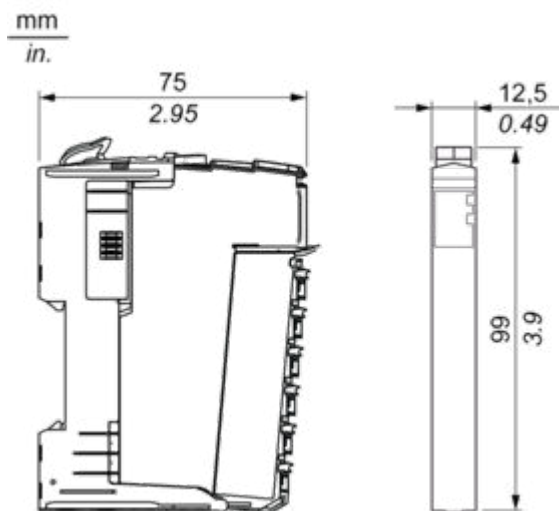

Mounting and Clearance

TM5 System

Spacing Requirements

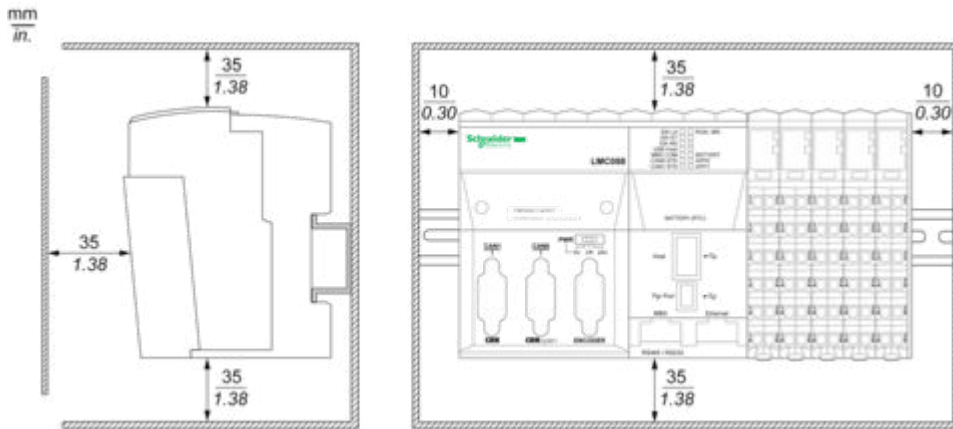



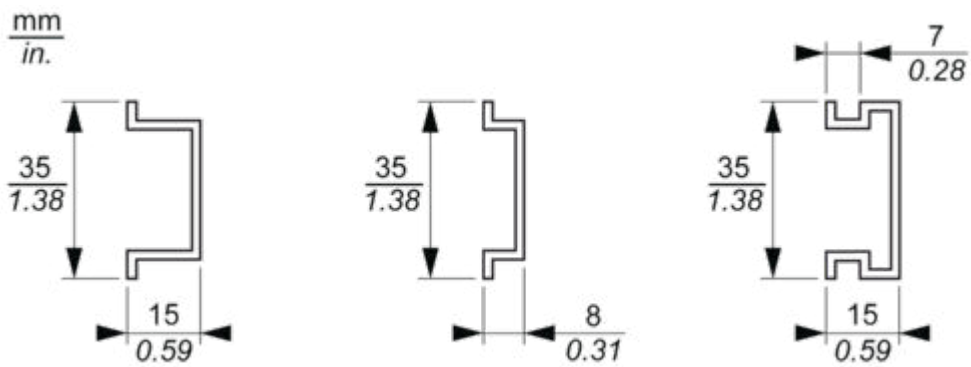

Mounting on a DIN Rail

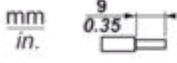

Connections and Schema

TM5 System Wiring Recommendations

Wire Sizes to Use with the Removable Spring Terminal Blocks

|  mm in. |  |  |  |  |
|--|---|---|---|---|
| mm ² | 0,08...2,5 | 0,25...2,5 | 0,25...1,5 | 2 x 0,25...2 x 0,75 |
| AWG | 28...14 | 24...14 | 24...16 | 2 x 24...2 x 18 |

