

Product data sheet

Specifications



power distribution module, Modicon TM5, 24V DC IO with bus

TM5SPS2

Main

Range Of Product	Modicon TM5
Product Or Component Type	Power distribution module
Product Specific Application	Supply 24 V DC I/O modules and bus TM5

Complementary

Range Compatibility	Modicon LMC058 Modicon M258
Product Compatibility	Motion controller Logic controller
[Us] Rated Supply Voltage	24 V
Network Type	DC
Current Supplied	1136 mA TM5 power bus 14...131 °F (-10...55 °C) 740 mA TM5 power bus 131...140 °F (55...60 °C) 10 A I/O power segment
Maximum Power Dissipation In W	1.91 W
Colour	Grey
Short-Circuit Protection	10 A external fuse
Current Consumption	<= 25 mA 24 V DC
Marking	CE

Environment

Standards	UL 508 CSA C22.2 No 213 CSA C22.2 No 142 IEC 61131-2
Product Certifications	CSA C-Tick cULus GOST-R
Ambient Air Temperature For Operation	14...131 °F (-10...55 °C) without derating horizontal installation) 131...140 °F (55...60 °C) with derating factor horizontal installation) 14...122 °F (-10...50 °C) vertical installation)
Ambient Air Temperature For Storage	-13...158 °F (-25...70 °C)
Relative Humidity	5...95 % without condensation
Operating Altitude	0...2000 m
Storage Altitude	0.00...9842.52 ft (0...3000 m)
Vibration Resistance	1 gn 8.4...150 Hz DIN rail 3.5 mm 5...8.4 Hz DIN rail

Shock Resistance	15 gn 11 ms
Resistance To Electrostatic Discharge	4 kV on contact EN/IEC 61000-4-2 8 kV in air EN/IEC 61000-4-2
Resistance To Electromagnetic Fields	0.91 V/yd (1 V/m) 2...2.7 GHz EN/IEC 61000-4-3 9.14 V/yd (10 V/m) 80...2000 MHz EN/IEC 61000-4-3
Resistance To Fast Transients	1 kV EN/IEC 61000-4-4 I/O) 1 kV EN/IEC 61000-4-4 shielded cable) 2 kV EN/IEC 61000-4-4 power lines)
Surge Withstand	0.5 kV differential mode EN/IEC 61000-4-5 1 kV common mode EN/IEC 61000-4-5
Electromagnetic Compatibility	EN/IEC 61000-4-6
Disturbance Radiated/Conducted	CISPR 11

Packing Units

Unit Type Of Package 1	PCE
Number Of Units In Package 1	1
Package 1 Height	0.79 in (2.000 cm)
Package 1 Width	2.36 in (6.000 cm)
Package 1 Length	4.13 in (10.500 cm)
Package 1 Weight	1.76 oz (50.000 g)
Unit Type Of Package 2	S02
Number Of Units In Package 2	97
Package 2 Height	5.91 in (15.000 cm)
Package 2 Width	11.81 in (30.000 cm)
Package 2 Length	15.75 in (40.000 cm)
Package 2 Weight	11.65 lb(US) (5.286 kg)

Contractual warranty

Warranty	18 months
-----------------	-----------

Sustainability

Green Premium™ label is Schneider Electric's commitment to delivering products with best-in-class environmental performance. Green Premium promises compliance with the latest regulations, transparency on environmental impacts, as well as circular and low-CO₂ products.

Guide to assessing product sustainability is a white paper that clarifies global eco-label standards and how to interpret environmental declarations.

[Learn more about Green Premium >](#)

[Guide to assess a product's sustainability >](#)



Transparency RoHS/REACH

Well-being performance

✓ Reach Free Of Svhc

✓ Toxic Heavy Metal Free

✓ Mercury Free

✓ Rohs Exemption Information [Yes](#)

✓ Pvc Free

Certifications & Standards

Reach Regulation

[REACH Declaration](#)

Eu Rohs Directive

Pro-active compliance (Product out of EU RoHS legal scope)

[EU RoHS Declaration](#)

China Rohs Regulation

[China RoHS declaration](#)

Environmental Disclosure

[Product Environmental Profile](#)

Weee

The product must be disposed on European Union markets following specific waste collection and never end up in rubbish bins

Circularity Profile

[End of Life Information](#)

Dimensions Drawings

TM5 Slice

Dimensions

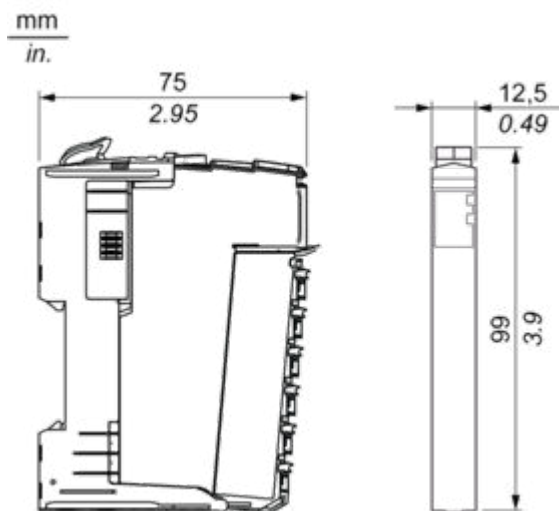

Mounting and Clearance

TM5 System

Spacing Requirements

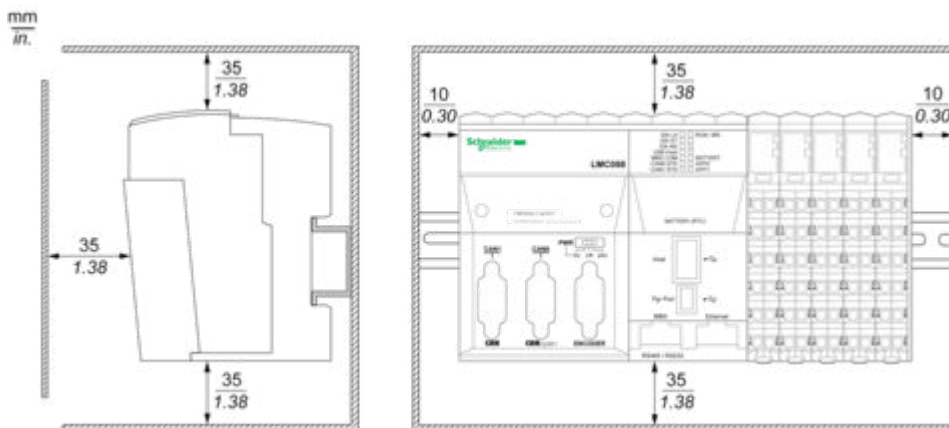



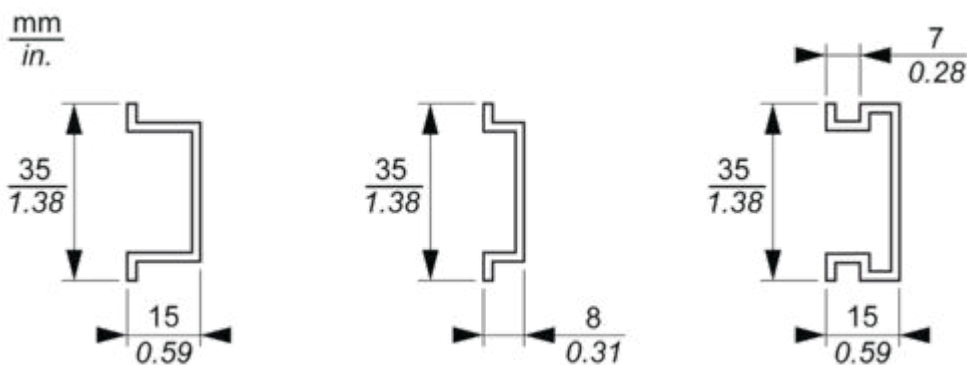

Mounting on a DIN Rail



Connections and Schema

TM5 System Wiring Recommendations

Wire Sizes to Use with the Removable Spring Terminal Blocks

 mm in.				
mm ²	0,08...2,5	0,25...2,5	0,25...1,5	2 x 0,25...2 x 0,75
AWG	28...14	24...14	24...16	2 x 24...2 x 18

PDM Electronic Module 24 Vdc I/O and TM5 Power Bus

Wiring Diagram

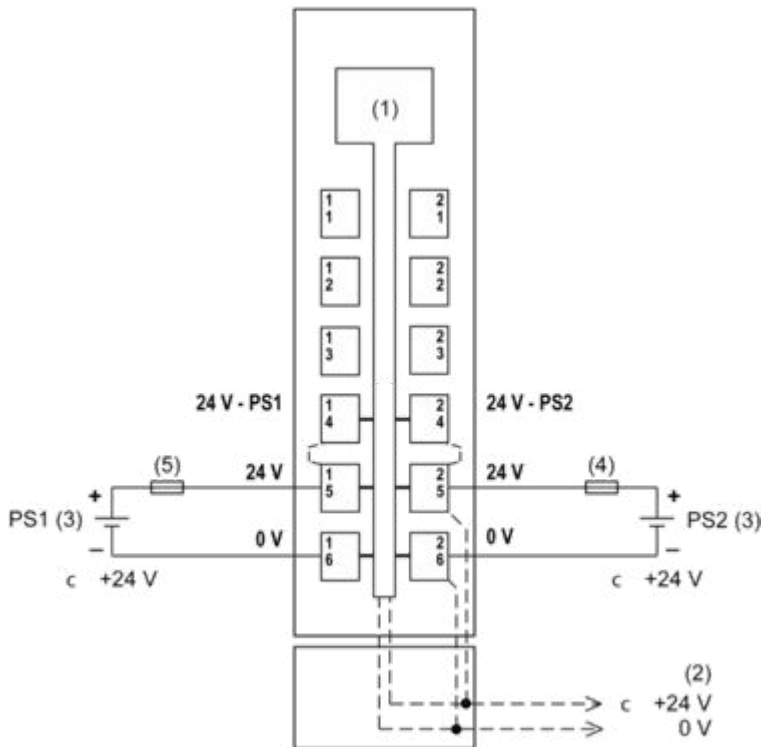

- (1) Internal electronics
- (2) 24 Vdc I/O power segment integrated into the bus bases
- (3) PS1/PS2: External isolated SELV power supplies 24 Vdc limited to 200 VA for UL508 conformance, or limited to 150 VA for CSA 22.2, N° 142 conformance
- (4) External fuse type T slow-blow 10 A max. 250 V
- (5) External fuse type T slow-blow 1 A 250 V