

Analog and non-indicating type, set temperature by dial

■ Features

- Non-indicating type
- Setting temperature by Dial
- Includes burn out function
- Universal power: TOS



⚠ Please read "Caution for your safety" in operation manual before using.

CAUS
(TOS Series only)

■ Ordering information

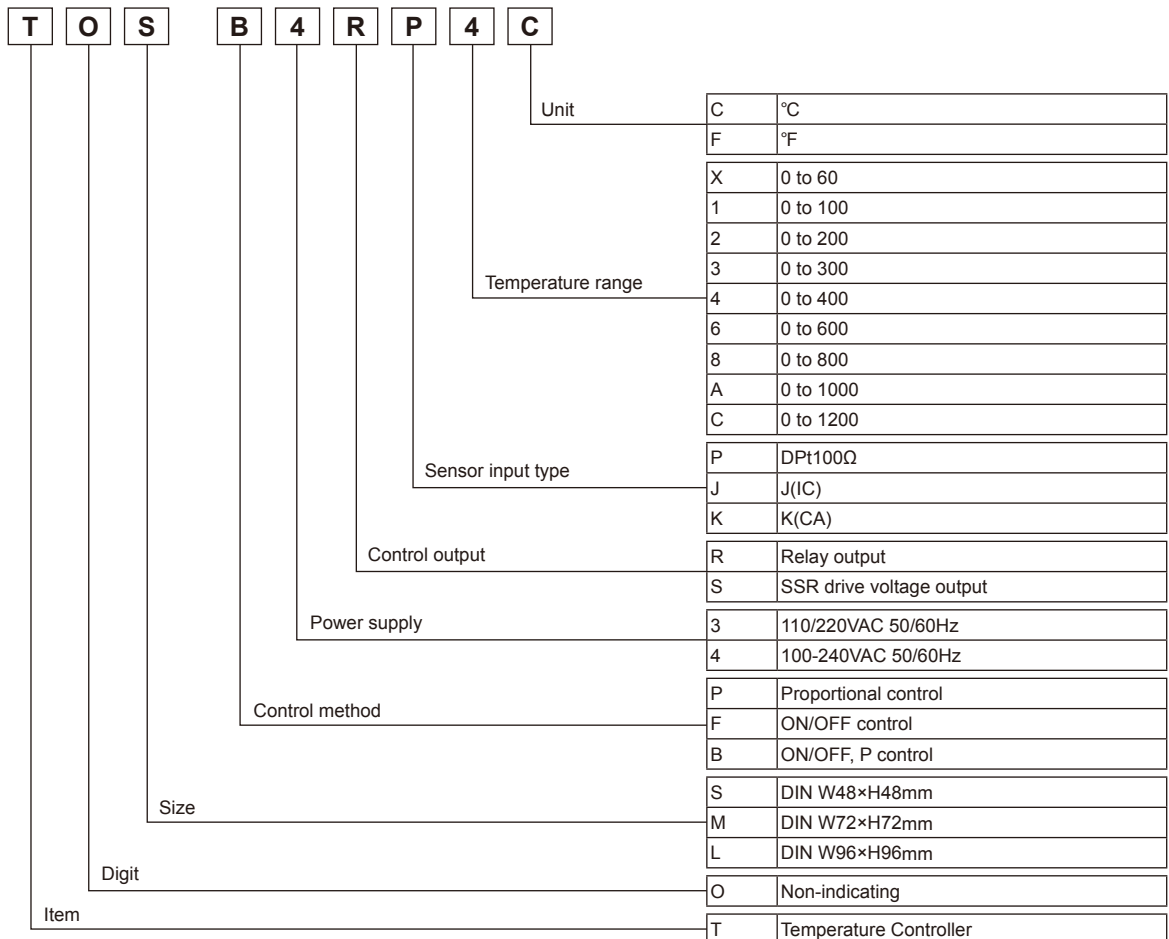

※Refer to the H-108 about sensor temperature range for selection.

- (A) Photo electric sensor
- (B) Fiber optic sensor
- (C) Door/Area sensor
- (D) Proximity sensor
- (E) Pressure sensor
- (F) Rotary encoder
- (G) Connector/Socket
- (H) Temp. controller
- (I) SSR/Power controller
- (J) Counter
- (K) Timer
- (L) Panel meter
- (M) Tacho/Speed/Pulse meter
- (N) Display unit
- (O) Sensor controller
- (P) Switching mode power supply
- (Q) Stepper motor & Driver & Controller
- (R) Graphic/Logic panel
- (S) Field network device
- (T) Software
- (U) Other

TOS/ TOM/ TOL

Temperature range for each sensor

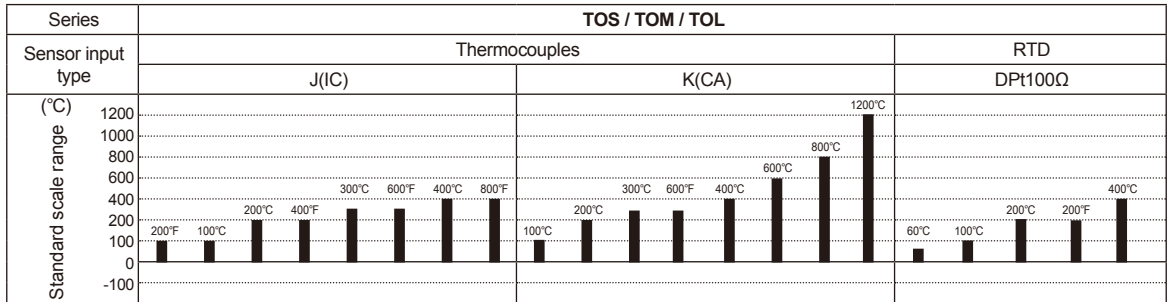

Specifications

Series	TOS	TOM	TOL
Power supply	100-240VAC 50/60Hz	110/220VAC 50/60Hz	
Allowable voltage range	90 to 110% of rated voltage		
Power consumption	Max. 2.2VA	Max.3VA	
Display method	LED ON	LED ON/OFF	
Setting type	Dial setting		
Setting accuracy	F.S. ±2%		
Sensor input	Thermocouples: K(CA), J(IC) / RTD: DPt100Ω		
Input line resistance	Thermocouples: Max. 100Ω, RTD: Allowable line resistance max. 5Ω per a wire		
Control method	ON/OFF	Hysteresis: F.S. 0.5% ±0.2% fixed	
	Proportional	Proportional band: F.S. 3% fixed, Period: 20sec. fixed	
Control output	<ul style="list-style-type: none"> Relay output: 250VAC 2A 1c SSR drive voltage output : 12VDC ±3V Load 20mA Max. 	<ul style="list-style-type: none"> Relay output: 250VAC 3A 1c SSR drive voltage output: 12VDC ±3V 20mA Max. 	
Self-diagnosis	Built-in burn out function (cut off output when sensor is disconnected)		
Insulation resistance	Min. 100MΩ (at 500VDC megger)		
Dielectric strength	2,000VAC 50/60Hz for 1 min.		
Noise resistance	±1kV the square wave noise(pulse width: 1μs) by the noise simulator		
Vibration	Mechanical	0.75mm amplitude at frequency of 10 to 55Hz(for 1 min.) in each of X, Y, Z directions for 1 hour	
	Malfunction	0.5mm amplitude at frequency of 10 to 55Hz(for 1 min.) in each of X, Y, Z directions for 10 min.	
Shock	Mechanical	300m/s ² (approx. 30G) in each of X, Y, Z directions for 3 times	
	Malfunction	100m/s ² (approx. 10G) in each of X, Y, Z directions for 3 times	
Relay life cycle	Mechanical	Min. 10,000,000 operations	
	Electrical	Min. 100,000 operations(250VAC 3A at resistive load)	
Environment	Ambient temperature	-10 to 50°C, storage: -25 to 65°C	
	Ambient humidity	35 to 85%RH, storage: 35 to 85%RH	
Approval		—	—
Unit weight	Approx. 104g	Approx. 419g	Approx. 426g

※F.S. is same with sensor measuring temperature range.

Ex) In case of using temperature is from 0 to 800°C, Full scale is "800".

※Environment resistance is rated at no freezing or condensation.

Analog Setting Non-Indicating type

■ Connections

※RTD: DPt100Ω(3-wire type) ※Thermocouple: K, J

● TOS

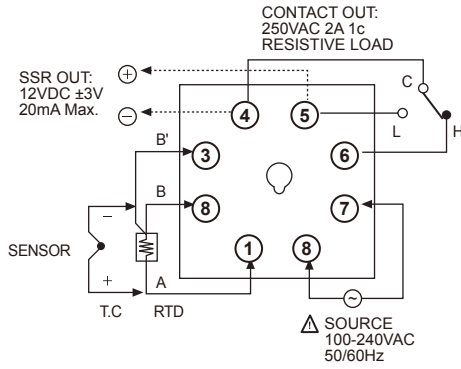

● TOM

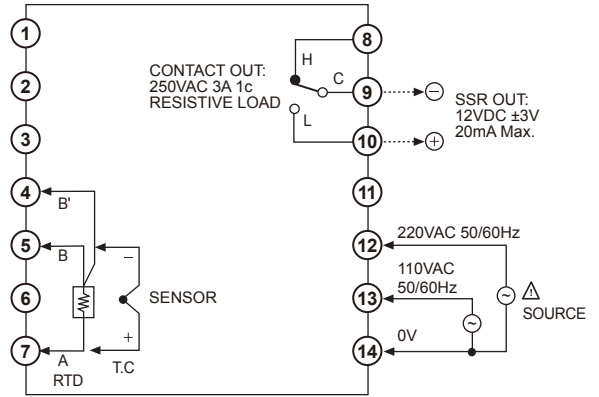

● TOL

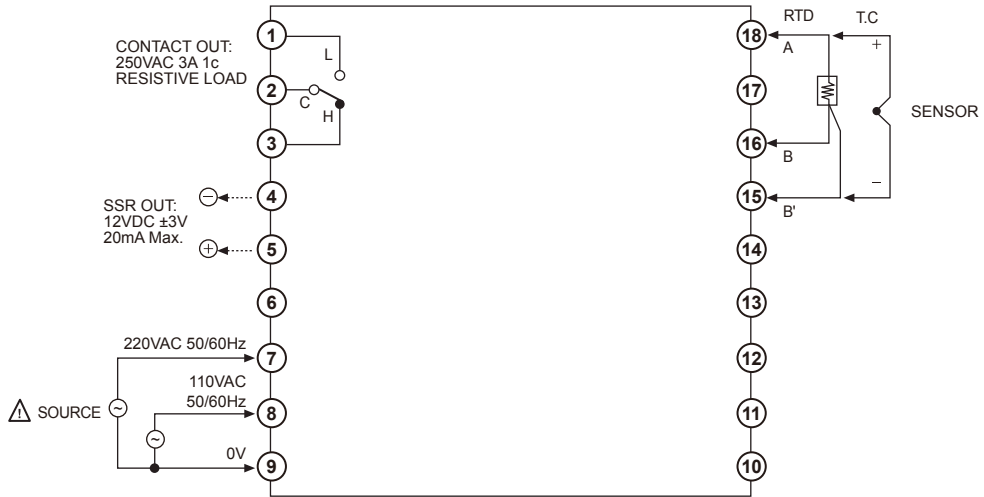

■ Dimensions

(unit: mm)

● TOS

<Bracket>

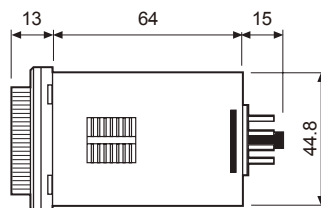
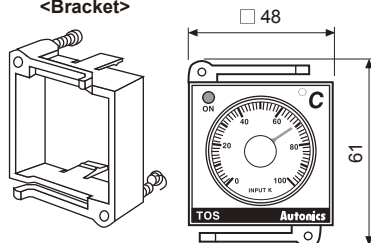

● Panel cut-out

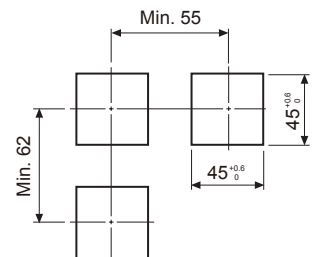

※Socket: PG-08, PS-08(sold separately)

(A) Photo electric sensor

(B) Fiber optic sensor

(C) Door/Area sensor

(D) Proximity sensor

(E) Pressure sensor

(F) Rotary encoder

(G) Connector/Socket

(H) Temp. controller

(I) SSR/Power controller

(J) Counter

(K) Timer

(L) Panel meter

(M) Tacho/Speed/Pulse meter

(N) Display unit

(O) Sensor controller

(P) Switching mode power supply

(Q) Stepper motor& Driver&Controller

(R) Graphic/Logic panel

(S) Field network device

(T) Software

(U) Other

TOS/ TOM/ TOL

Dimensions

(unit: mm)

● TOM

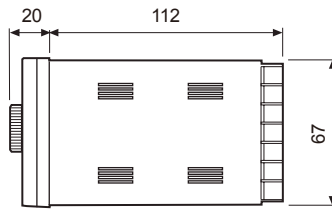
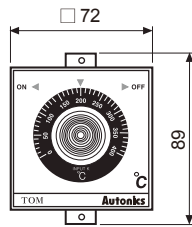

●Panel cut-out

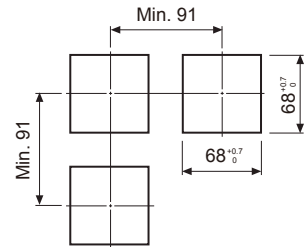

● TOL

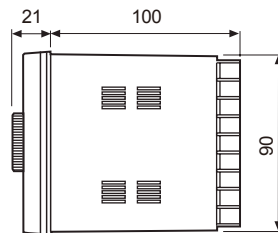
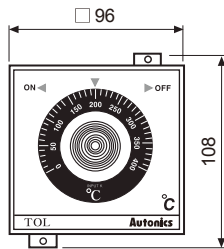

●Panel cut-out

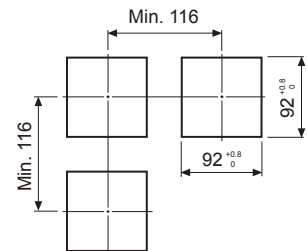

Proper usage

◎ Application of temperature controller and load connection

● SSR drive voltage output connection

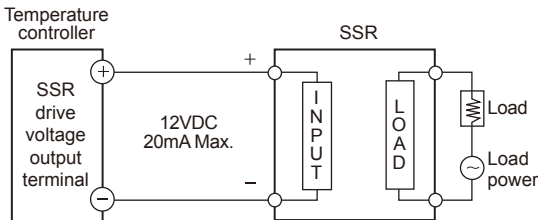

※When using voltage(for driving SSR) in the other purposes, do not over the range of the rated current.

● Relay output connection

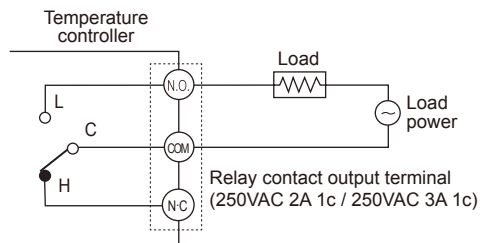

◎ Normal/Reverse operation

Reverse operation executes to output ON when processing value is lower than setting value, and it is used for heating.

Normal operation is executed conversely and used for cooling. (This item runs as a reverse operation.)

◎ How to select control mode

Factory specification is P control. When using ON/OFF control, transfer the switch of control method from P to F after detaching the case from its body.

Note)Several models require to change control method by jump line or solder.



◎ Case detachment

● TOM, TOL

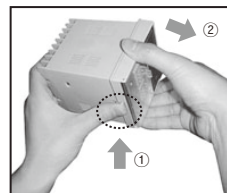

Pressing the front guide of Lock toward ① and squeeze and pull toward ②, it is detached.

● TOS

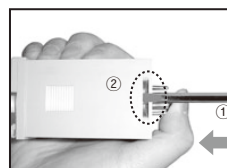

Pressing Pin plug ①, raise it up with a driver as ② and it is detached.

※Refer to the H-141 page for caution for using and simple error diagnosis.